

# See Brilliance, Color and Light Through **CANON'S LENS TECHNOLOGY**



P.5-27 | BROADCAST LENSES |

P.28-39 | CINEMA LENSES |

P.40-41 | PAN-TILT SYSTEMS |

**Canon**

## CANON BROADCAST ZOOM LENSES

# Celebrating Canon's Storied History

### Development of Broadcast Zoom Lenses

In 1958, Canon launched its broadcast lens business by introducing the innovative high zoom ratio 6.7 IF-1 lens. Ever since, Canon has continued to listen to the demands of broadcasters and cinematographers around the world by developing lenses based on industry trends.

### Canon's Emmy®-Winning Lens Technology

Canon's highly regarded lens technology is a recipient of the Technology and Engineering Emmy® Award from The National Academy of Television Arts and Sciences (NATAS). This award was the result of an evaluation on technology development and innovation in the broadcasting industry and is awarded to companies or individuals who have made remarkable contributions to the broadcasting industry.



# CANON'S LENS TECHNOLOGY: WELCOME TO THE 4K UHD ERA

Canon has been an innovator in the video industry for more than half a century. Today, Canon's innovation continues with the development of 4K lens technology. State-of-the-art optical and mechanical technology was born from tireless research, materials engineering, and production technology. Rigorous evaluation and tests developed innovative products with high-end optical design, operability and reliability.

While approaching the 60th anniversary of servicing the broadcast industry, Canon's advanced lens technology continues to deliver beautiful high-end imaging. Today we offer an exciting range of innovative high-end imaging products that stimulate creativity and deliver superb results, as we continue our pioneering pursuit of excellence into the 21st century.



UHD DIGISUPER 90



CJ20ex7.8B



CJ12ex4.3B



CN7x17 KAS 5/E1/P1



CN-E14.5-60mm T2.6 L S  
CN-E14.5-60mm T2.6 L SP



CN-E30-300mm T2.95-3.7 L S  
CN-E30-300mm T2.95-3.7 L SP



CN-E15.5-47mm T2.8 L S  
CN-E15.5-47mm T2.8 L SP



4K



4K Premium UHD DIGISUPER 86



4K Premium UHD DIGISUPER 27

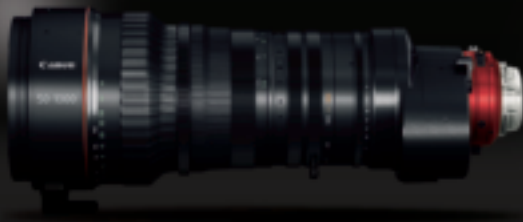

CN20x50 IAS H/E1/P1



CN-E70-200mm T4.4 L IS KAS S



CN-E18-80mm T4.4 L IS KAS S



CN-E30-105mm T2.8 L S  
CN-E30-105mm T2.8 L SP



CN-E14mm T3.1 L F



CN-E24mm T1.5 L F



CN-E35mm T1.5 L F



CN-E50mm T1.3 L F



CN-E85mm T1.3 L F



CN-E135mm T2.2

# Broadcast Zoom Lens Lineup



Studio & Field  
Lenses



ENG/EFP  
Lenses



Pro-Video &  
Remote-Controlled  
Lenses

## Broadcast Studio and Field Lenses

P. 14 - 15

<b>4K UHD 2/3"</b>	UHD DIGISUPER 86 <b>4K Premium</b> UHDxs 	UHD DIGISUPER 90 <b>4K</b> UHDxs 	UHD DIGISUPER 27 <b>NEW</b> <b>4K Premium</b> UHDxs 
<b>HD 2/3"</b>	DIGISUPER 100AF <b>HD</b> Air Auto Focus 	DIGISUPER 100 <b>HD</b> Air 	DIGISUPER 95 TELE <b>HD</b> Air 
	DIGISUPER 95 <b>HD</b> Air 	DIGISUPER 86AF <b>HD</b> Air Auto Focus 	DIGISUPER 80 <b>HD</b> Air 
	DIGISUPER 76 <b>HD</b> Air 	DIGISUPER 60 xs <b>HD</b> Air 	DIGISUPER 27AF <b>HD</b> Air Auto Focus 
	DIGISUPER 27 <b>HD</b> Air 	DIGISUPER 22 xs <b>HD</b> Air 	

## Broadcast ENG/EFP HDXS Lenses

P. 18 - 19

<b>4K UHD 2/3"</b>	CJ20e×7.8B <b>4K</b> UHDxs 	CJ12e×4.3B <b>4K</b> UHDxs 	
<b>HD 2/3"</b>	HJ40e×14B <b>HD</b> Air 	HJ40e×10B <b>HD</b> Air 	HJ15e×8.5B <b>HD</b> XS 
	HJ18e×28B <b>HD</b> XS 	HJ21e×7.5B <b>HD</b> XS 	HJ24e×7.5B <b>HD</b> XS 
	HJ18e×7.6B <b>HD</b> XS 	HJ17e×6.2B <b>HD</b> XS 	HJ14e×4.3B <b>HD</b> XS 

## HDGC Lenses

P. 20

<b>HD 2/3"</b>	KJ22e×7.6B <b>HD</b> GC 	KJ17e×7.7B <b>HD</b> GC 	KJ10e×4.5B <b>HD</b> GC 
	KJ20×8.2B (IRSD) <b>HD</b> GC 	KJ20×8.2B (KRSD) <b>HD</b> GC 	KJ13×6B <b>HD</b> GC 
<b>HD 1/2"</b>	KH20×6.4 <b>HD</b> GC 	KH13×4.5 <b>HD</b> GC 	
<b>HD 1/3"</b>	KT17e×4.3B <b>HD</b> GC 	KT20×5B <b>HD</b> GC 	

## Remote Controlled Lenses

P. 21

<b>HD 2/3"</b>	HJ18e×28B (ITS-ME) 	HJ24e×7.5B (ITS-ME) 	HJ18e×7.6B (ITS-ME) 
	HJ14e×4.3B (ITS-ME) 	KJ17e×7.7B (ITS-ME) 	KJ22e×7.6B (ITS-ME) 
	KJ20×8.2B (KTS) 	KH20×6.4 (KTS) <b>HD 1/2"</b> 	KT20×5B (KTS) <b>HD 1/3"</b> 

# CANON BROADCAST LENSES

## Understanding Canon Lens Naming Conventions

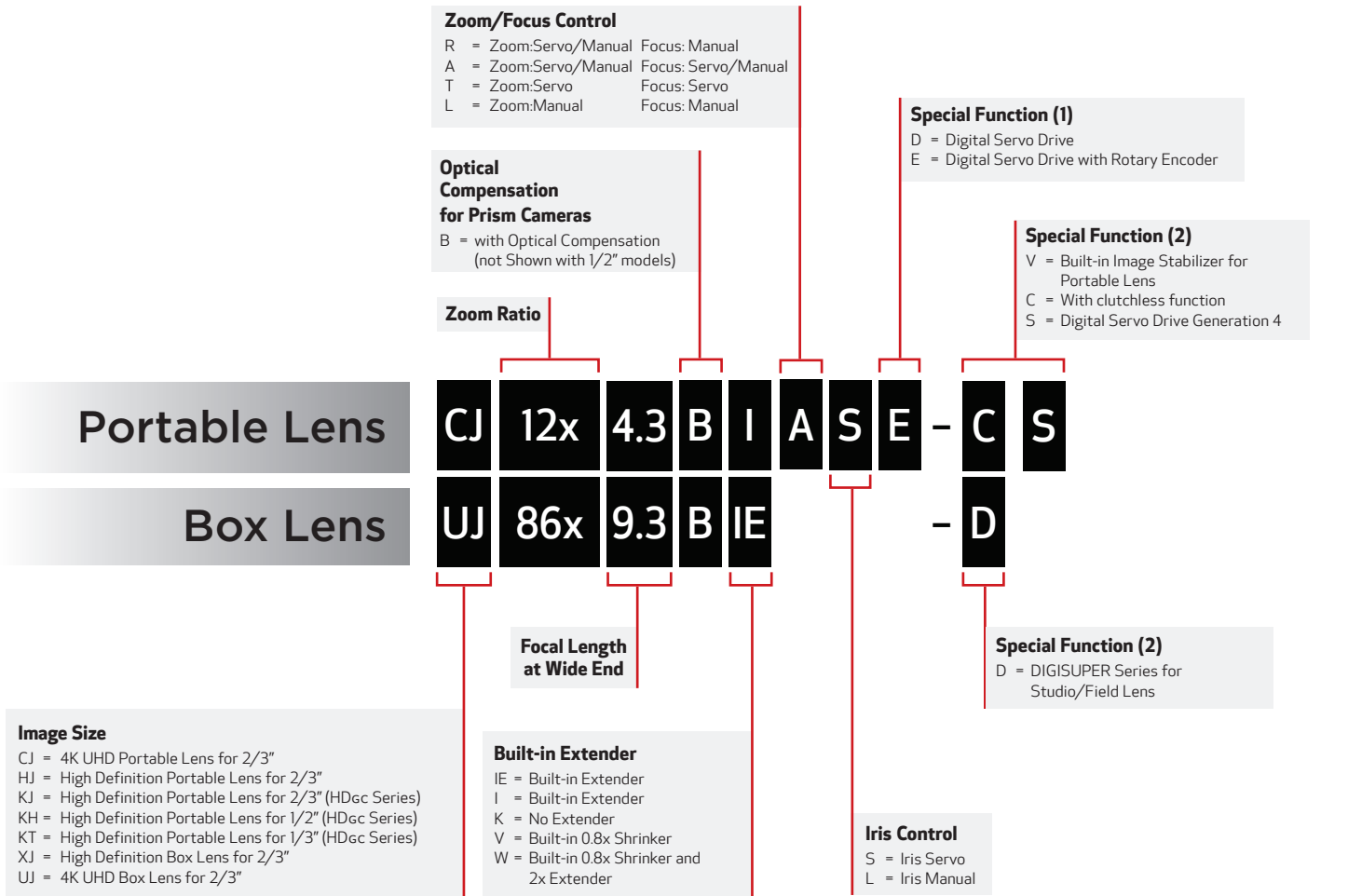

### UHDxs

Canon's optical technologies continue to evolve with the UHDxs "Power Optical System" which corrects various optical aberrations seen when broadcasting 4K imagery.

- Please refer to P11 for more information regarding the "Power Optical System."

### HDxs HDXS

HDxs is a high performance HD lens series which also adopts the Power Optical System technology. The Power Optical System maximizes the characteristics of high-performance optical materials.

### HDGC

HDGC is a cost effective HD lens series that satisfies the optical performance requirements of HDTV at a cost-effective price.



Focal Length Table

Broadcast, Studio and Field Lenses (4K 2/3", HD 2/3")																						
Angle of view horizontal (16:9)	72.9°	66.7°	58.3°	57.2°	56.1°	54.6°	42.3°	39.1°	3.4°	3.1°	1.02°	0.98°	0.81°	0.80°	0.77°	0.69°	0.68°	0.67°	0.65°	0.59°	0.47°	
Focal Length (mm)	6.5	7.3	8.6	8.8	9	9.3	12.4	13.5	161	180	540	560	675	690	710	800	810	820	840	930	1178	
UHD DIGISUPER 90																						
UHD DIGISUPER 86																						
UHD DIGISUPER 27																						
DIGISUPER 100 AF																						
DIGISUPER 100																						
DIGISUPER 95 TELE																						
DIGISUPER 95																						
DIGISUPER 86 AF																						
DIGISUPER 80																						
DIGISUPER 76																						
DIGISUPER 60 xs																						
DIGISUPER 27 AF																						
DIGISUPER 27																						
DIGISUPER 22 xs																						

Broadcast ENG/EFP HXS Lenses (4K 2/3", HD 2/3")																																			
Angle of view horizontal (16:9)	96.3°	93.7°	77.3°	75.5°	65.2°	64.6°	63.9°	63.2°	60.7°	58.9°	51.3°	47.1°	35.5°	37.8°	19.6°	12.2°	10.5°	9.1°	7.0°	5.2°	4.3°	4.2°	4.0°	3.5°	3.5°	3.4°	3.3°	3.1°	1.45°	1.4°	1.1°	1.15°	1.0°		
Focal Length (mm)	4.3	4.5	6	6.2	7.5	7.6	7.7	7.8	8.2	8.5	10	11	15	14	28	45	52	60	78	106	128	131	137	156	158	164	168	180	385	400	500	525	560		
CJ20ex7.8B																																			
CJ12ex4.3B																																			
HJ40ex14B																																			
HJ40ex10B																																			
HJ18ex28B																																			
HJ24ex7.5B																																			
HJ21ex7.5B																																			
HJ18ex7.6B																																			
HJ17ex6.2B																																			
HJ14ex4.3B																																			
HJ15ex8.5B																																			

HGC Lenses (HD 2/3")																																			
Angle of view horizontal (16:9)	96.3°	93.7°	77.3°	75.5°	65.2°	64.6°	63.9°	63.2°	60.7°	58.9°	51.3°	47.1°	35.5°	37.8°	19.6°	12.2°	10.5°	9.1°	7.0°	5.2°	4.3°	4.2°	4.0°	3.5°	3.5°	3.4°	3.3°	3.1°	1.45°	1.4°	1.1°	1.15°	1.0°		
Focal Length (mm)	4.3	4.5	6	6.2	7.5	7.6	7.7	7.8	8.2	8.5	10	11	15	14	28	45	52	60	78	106	128	131	137	156	158	164	168	180	385	400	500	525	560		
KJ22ex7.6B																																			
KJ17ex7.7B																																			
KJ10ex4.5B																																			
KJ20x8.2B																																			
KJ13x6B																																			

HGC Lenses (HD 1/2")																																											
Angle of view horizontal (16:9)	75.7°			57.1°																																							
Focal Length (mm)	4.5			6.4																																							
KH20x6.4																																											
KH13x4.5																																											

HGC Lenses (HD 1/3")																																										
Angle of view horizontal (16:9)	58.3°	51.9°																																								
Focal Length (mm)	4.3	5																																								
KT17ex4.3B																																										
KT20x5B																																										

# Canon Broadcast Lens Technology

## Optical Performance

### Superb Optical Materials Produce a High-Performance Lens

#### Fluorite · UD Glass · Hi-UD Glass

Unlike conventional optical glass, Fluorite has remarkably low dispersion properties. Realizing the effectiveness of Fluorite glass, Canon has put it to practical use in many lenses, primarily in the anterior section of zoom lenses to help correct telephoto chromatic aberration. Both UD<sup>1</sup> glass and Hi-UD glass<sup>2</sup>



have dispersion properties similar to Fluorite and are effective for correcting chromatic aberration. Due to its high refractive characteristics, Hi-UD glass is especially known for its spherical aberration correction. Used in the anterior and zooming sections of a lens, Hi-UD glass is effective for controlling aberration fluctuation seen when focusing and zooming.

<sup>1</sup> UD-Ultra Low Dispersion.

<sup>2</sup> Hi-UD High Index Ultra Low Dispersion.

### High Quality, Compact Size and Weight

#### Large Aperture Aspheric Lens

Spherical aberration will increase as the diameter of a spherical lens increases. However, aspheric lenses form an ideal shape for aberration correction and are the desired lens type for improving optical performance. As they are more compact, aspheric lenses reduce the weight of the entire lens system. Through its optical design and large aperture processing techniques, Canon has developed compact, large aperture, high magnification field zoom aspheric lenses. As a result of this development, all high-

magnification field zoom lenses released since 2000 have a constant total lens length regardless of zoom ratio.

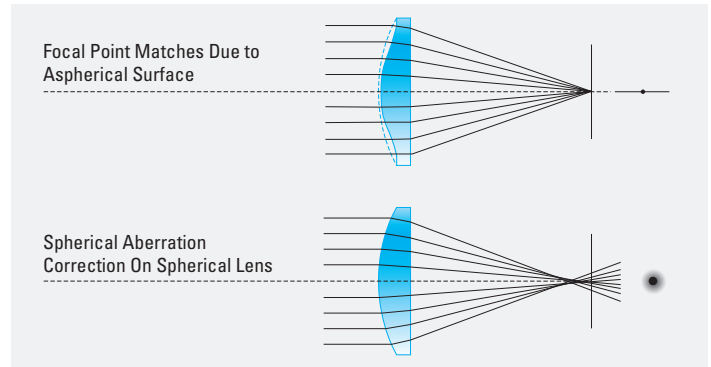

### Focus Breathing Suppression

#### Constant Angle Focusing System (CAFS)

CAFS is a technology that suppresses view-angle fluctuation (breathing) while focusing. The Zooming Effect of Focus is the phenomenon where the picture size (angle of view) changes when focusing. Canon's 32-bit CPU calculates and controls the zoom when focusing in order to counteract this phenomenon. As a result of CAFS, the UHD DIGISUPER and DIGISUPER Series has zero Zooming Effect of Focus.

### Optical Performance and Operability

#### Inner Focus "IF" Method

In the early stages of broadcast lens development, Canon adopted the inner focus method in order to help improve the optical performance and operability of broadcast lenses. Because of the IF Method, Canon was able to make several notable achievements: decreasing the M.O.D. of studio/field lenses, achieving wider angle focal ranges, reducing chromatic aberration fluctuation due to focusing and reducing distortion. Low power consumption and high speed driving were also achieved by reducing the weight of the focus lens group. Additionally, portable lens ghosting and flares have been reduced by using a rectangular lens hood and by preventing filter rotation.

### ■ Secondary Imaging Phase Difference Detection Method (Conceptual Diagram).

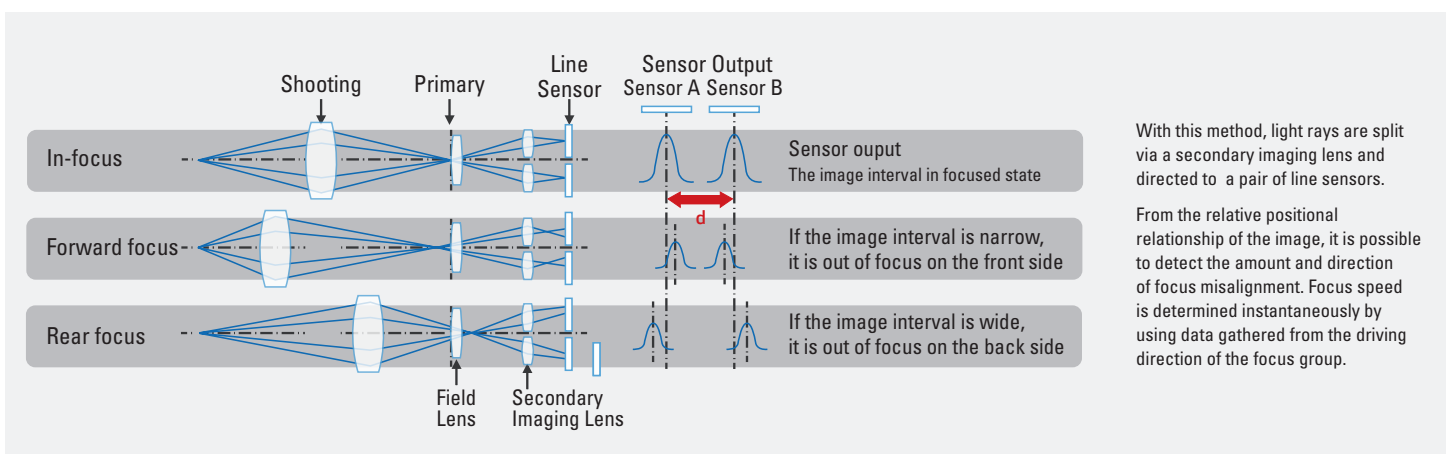

With this method, light rays are split via a secondary imaging lens and directed to a pair of line sensors.

From the relative positional relationship of the image, it is possible to detect the amount and direction of focus misalignment. Focus speed is determined instantaneously by using data gathered from the driving direction of the focus group.

## Advanced Design Technology to Help Minimize Various Aberrations

### Power Optical System

At Canon, advanced broadcast lens optical design is made possible by optical simulation and the theoretical analysis of aberration. This “Power Optical System” design technology helps to maximize the characteristics of high-performance optical materials and achieves a wide range of aberration correction.

## Auto Focus

### TTL Secondary Imaging Phase Difference Detection Method

The Secondary Imaging Phase Difference Detection Method, also used in single lens reflex EOS camera lenses, was adopted for broadcast autofocus systems. As a result of this Method, Canon’s Auto Focus System has excellent focusing accuracy within the entire zoom range, along with outstanding focusing speed. Due to high performance servo motors, tracking a moving object at high speed can be possible even from a largely out of focus state.

### Autofocus Two Types of Operation

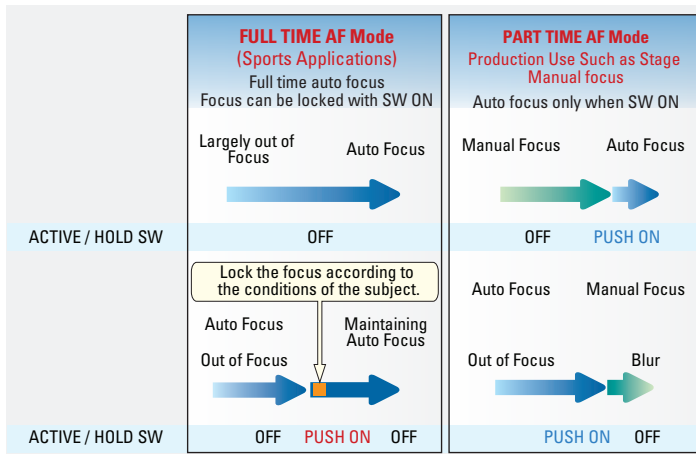

### AF Mode

Select DIGISUPER lenses provide two autofocus modes. “FULL TIME AF” provides continuous autofocus operation allowing the camera operator to focus on framing the subject. “PART TIME AF” allows for temporary autofocus use with manual focus. The modes can be switched on and off as needed, using the ACTIVE/HOLD switch.

### AF In-Focus Display

By using the FDJ - P41 dedicated focus demand, you can change the size (3 options) and position of the AF in - focus frame displayed on the viewfinder\*.

\*To change the in-focus frame, it is necessary to interlock with the camera.

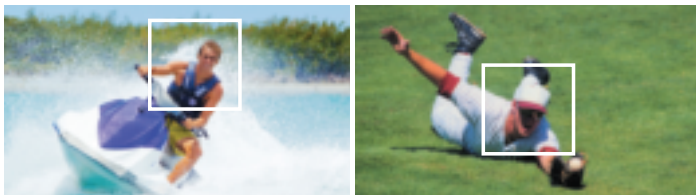

## Digital Technology

### Digital Servo System/Digital Drive Unit

Since the release of the DIGISUPER 70 in 1995, Canon has been a leader in digital broadcast zoom lens control. Canon’s ENG/EFP lenses, having the same digital technology, offer a wealth of features to make shooting more efficient. Canon’s digital drive unit is installed in all ENG/EFP and Provideo broadcast lenses.

### Shuttle Shot

At the touch of a button, this feature allows the operator to zoom back and forth instantly between any two positions at the maximum speed or at any speed memorized in the Speed Presets.

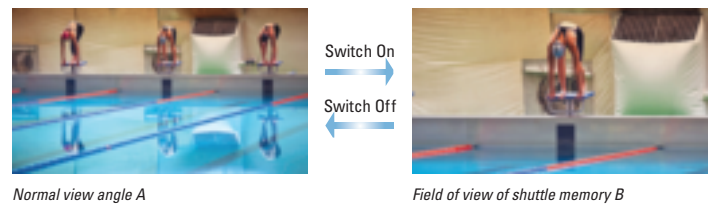

### Frame Preset

With the Frame Preset feature, a preset frame position can be saved and repeated multiple times.

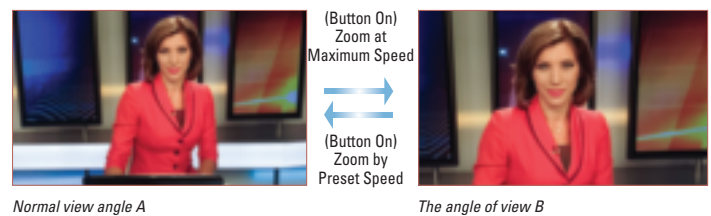

### Speed Preset

Simply press a button to recall the preset zoom speed.

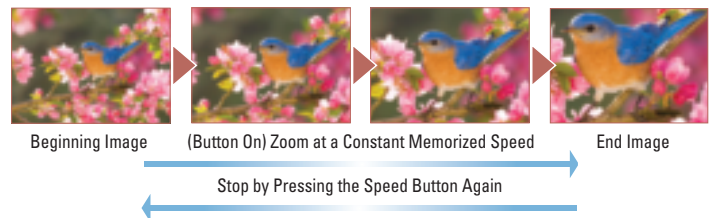

### Zoom Servo Characteristics

Zoom Servo characteristics can be selected from two curvature options on the ZDJ-P01 zoom demand.

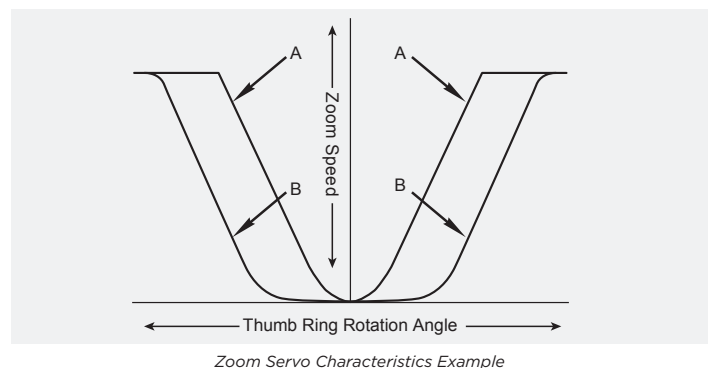

## Virtual Studio System

Canon has a series of HDxs and HDGC (IRSE/IASE version) lenses which are equipped with an enhanced digital drive unit. The digital drive unit's 16-bit encoder makes detection and output of positional information possible at a much higher resolution than an analog position sensor (equivalent to 10 bits). The 16-bit resolution rotary encoder built into the drive unit can be integrated into a virtual studio system. The encoders enable precise control as the zoom servo has a range of 0.5 second quick zooms to over a 5 minute super slow zoom. Repeatability in focus and iris control are also precise. Canon's technology has made the encoder device very small, allowing it to be installed in the existing drive unit without adding size or weight.

## Further Improving Operational Efficiency

### Type S Drive Unit

Canon has improved the operational efficiency of its lenses with the adoption of the Type S Drive Unit <sup>\*1</sup>.

- Matches the aberration correction function on the camera without initialization at power-on
- Reduced power consumption by about 10% <sup>\*2</sup> when using a battery as compared with previous versions
- Real and virtual images can easily be calibrated with high-precision position detection
- Three 20 PIN connectors allow for simultaneous full servo and virtual system operation
- Easy operation with straightforward menu and display

<sup>\*1</sup>: Please refer to page 6, Understanding Canon Naming Conventions, Special Functions (2).

<sup>\*2</sup>: When zoom, focus & iris in operation.

## Zoom Track

The zoom control range can be set within a more limited range on both the telephoto and wide-angle sides of UHD DIGISUPER and DIGISUPER Series lenses. With these lenses and the optional ZDJ-P01 zoom demand, the zoom range can be set to virtually any range smaller than the full focal range of the lens. If not used to limit the zoom range, the feature can be used to memorize an additional preset zoom position.

## Optical Anti-Vibration Mechanism

### Image Stabilizer (IS)

Canon launched its first field zoom lens with a shift type anti-vibration mechanism in 2000\*. Prior to that, Canon introduced the IS-20B anti-vibration adapter for portable zoom lenses. Those cutting-edge technologies, along with the Vari-angle Prism image stabilizer (VAP-IS) lens, helped to usher in the era of optical image stabilization in broadcasting lenses.

<sup>\*</sup>Adopted for DIGISUPER 86 XS (MJ86 × 9.3 B). The world's first field zoom lens for broadcasting.

## ■ Lens Shift Method (Shift-IS)

At an early stage of its history, Canon succeeded in developing an in-lens image stabilization mechanism in EF lenses. This technology was then adopted for high precision, high performance broadcast lenses. When vibration is detected by the sensor in Canon image stabilized broadcast lenses, the Correction Optical System Lens Group within the lens moves in a direction perpendicular to the optical axis, therefore refracting light and canceling out the image blur. Since the Correction Optical System is internal to the lens, the entire optical system can be downsized. Shift-IS is especially important for high magnification zoom lens with long focal lengths.

### Shift-IS

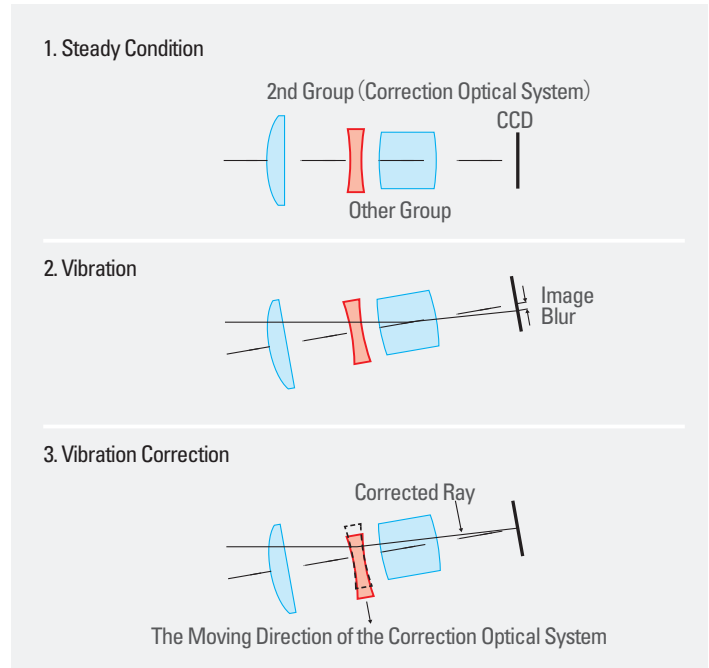

## Ergonomic Design

### Compact and Lightweight Drive Unit

Canon's HDxs, and HDGC (IRSE/IASE models) Ergonomic Drive Units are tilted at an ideal angle of 12.5 degrees to realize good balance and comfort. An informational display has been added which now allows the user to customize the enhanced digital functions easily, precisely and fully. The enhanced digital functions are easily accessed and set using the Digital Function Selector, an X-Y axis switch located next to the display.

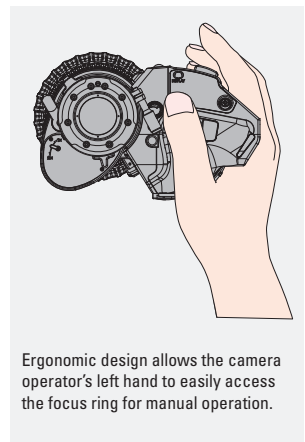



## 4K UHD Technology

### NEW BCTV LENSES DESIGNED TO SUPPORT THE TRANSITION TO 4K UHD CONTENT CREATION

While some regions are still making the transition, HDTV is now firmly established worldwide. HDTV production is expected to continue for many years to come. At the same time 4K digital cinema is rapidly expanding as a production format (largely Super 35mm) for theatrical motion picture origination and for many television episodic dramas and documentaries. Spurred by the 2015 publication of the international standards ITU-R BT.2020 for UHDTV and by the more recent 2016 companion ITU-R BT.2100 standard there is increasing attention being paid to adoption of 4K UHD origination of sports, concerts, and major events. The anticipated protracted coexistence of HDTV and UHDTV has spawned a new generation of 2/3-inch multiformat camera systems that can selectively originate HD or UHD from most of the major international camera manufacturers. The now well established digital cinema 2K and 4K production standards are also being incorporated into those new generation cameras. To support this new era of mixed HD / UHD origination Canon has invested heavily into the development of an array of 2/3-inch 4K UHD broadcast lenses that encompass long zoom field lenses, a studio lens, and portable lenses.

### THE CHALLENGE OF 4K

4K UHD has four times the spatial samples of the HDTV production format. That defines unusually small photosites in the small format 2/3-inch image sensors used in the new multiformat cameras. While posing new challenges in the design of such image sensors it also offers attendant significant technical challenges for the related optical front. Delivering the requisite high image sharpness required for 4K UHD while simultaneously lowering traditional optical aberrations (that can be more exposed by the high resolution image sensors) called for multiple innovations in lens design and manufacturing.

### 2/3-INCH UHD ZOOM LENSES

#### DESIGNED TO SUPPORT TODAY'S BROADCAST SYSTEMS - BOTH 4K UHD AND HDTV

The essence of 4K optical resolution centers on the ability to transmit exceptionally fine detail with high contrast. Modulation Transfer Function (MTF) is the method employed to specify and measure the behavior of a lens over a wide range of spatial frequencies. For HDTV, the lens must be able to project 100 line pairs per millimeter (LP/mm) with high contrast onto the 2/3-inch image sensor. For 4K UHD this becomes 200 LP/mm - with equally high contrast. It takes contemporary optical design techniques to optimize the huge number of variables in a multi-element zoom lens that can reach such specifications. Elevating that design challenge are the five monochromatic (wavelength independent) aberrations and the two chromatic aberrations (wavelength dependent) that are indigenous to all optical elements. These aberrations collectively conspire to attenuate lens resolution as well as imparting their own unique distortions to imagery. Combinations of new glass materials and innovative groupings of the same are the basis to help minimize



them. Achieving high contrast and elevating MTF also relies heavily on the innovative deployment of multilayer optical coatings on each and every lens element surface. The recent emergence of High Dynamic Range (HDR) and Wide Color Gamut (WCG) as highly desirable image enhancements to both HDTV and to 4K UHD has served to further elevate the challenge in reducing the optical aberrations. In particular, the minimization of lateral and longitudinal chromatic aberrations is of paramount importance here.

It is especially important to note that the deployment of the new 4K UHD lenses on existing HDTV cameras will produce a visible enhancement to the HD imagery. Thus, investing in these lenses today delivers a distinct advantage while offering future proofing toward a later transition to an 4K UHD camera system.

### WHAT IS "4K PREMIUM"?



Just as HDTV production evolved into a range of lenses and cameras that offered a hierarchy in Cost / Performance matching the wide levels in production budgets and creative aspirations - the same is anticipated in 4K UHD production. Canon has prepared for this by offering two levels in 4K lenses. The base level lenses offer full 4K performance. Anticipating that high-profile high-budget production of certain sporting and other major events in 4K UHD will be important going forward, Canon has developed a higher level of 4K UHD lens performance that is termed "4K PREMIUM". Special design techniques and optical materials were mobilized to further elevate resolution beyond contemporary 4K specifications - across the entire image plane—while also definitively lowering the two chromatic aberrations to the point of total invisibility.

### FOR MORE RESOURCES ON 4K LENS TECHNOLOGY:

Science of 4K Optics: <https://www.usa.canon.com/internet/portal/us/home/products/4k-lenses>  
 HDR - What It Is And Is Not: <https://vimeo.com/162867364?RID=1-S6CCWC&CON=1-82Z-305&PRO=&CID=1-S2RKWO>  
 Wide Color Gamut: <https://vimeo.com/180755554>

# Broadcast Studio/Field Lenses

## 4K UHD 2/3"

Appearance	UHD DIGISUPER 86 UHDxs		UHD DIGISUPER 90 UHDxs		UHD DIGISUPER 27 UHDxs	
						
	IMAGE STABILIZER		IMAGE STABILIZER		NEW	
	4K Premium		4K		4K Premium	
Model Name	UJ86x9.3B		UJ90x9B		UJ27x6.5B	
Zoom Ratio	86x		90x		27x	
Focal Length	9.3 ~ 800mm	18.6 ~ 1600mm (2.0x)	9 ~ 810mm	18 ~ 1620mm (2.0x)	6.5 ~ 180mm	13 ~ 360mm (2.0x)
Maximum Relative Aperture	F1.7 (9.3 ~ 340mm) F4.0 (800mm)	F3.4 (18.6 ~ 680mm) F8.0 (1600mm)	F2.4 (9 ~ 486mm) F4.0 (810mm)	F4.8 (18 ~ 972mm) F8.0 (1620mm)	F1.5 (6.5 ~ 123mm) F2.2 (180mm)	F3.0 (13 ~ 246mm) F4.4 (360mm)
Angular Field of View	54.6°×32.4° (9.3mm) 0.69°×0.39° (800mm)	28.9°×16.5° (18.6mm) 0.34°×0.19° (1600mm)	56.1°×33.4° (9mm) 0.68°×0.38° (810mm)	29.9°×17.1° (18mm) 0.34°×0.19° (1620mm)	72.9°×45.1° (6.5mm) 3.1°×1.7° (180mm)	40.5°×23.5° (13mm) 1.5°×0.9° (360mm)
M.O.D.*	3.0m		3.0m		0.6m	
Object Dimensions at M.O.D.*	271.9×152.9cm (9.3mm) 3.3×1.9cm (800mm)	136.0×76.5cm (18.6mm) 1.7×1.0cm (1600mm)	287.9×161.9cm (9mm) 3.3×1.9cm (810mm)	144.0×81.0cm (18mm) 1.7×1.0cm (1620mm)	106.1×59.7cm (6.5mm) 3.8×2.1cm (180mm)	53.1×29.9cm (13mm) 1.9×1.1cm (360mm)
Approx. Size (WxHxL)	9.9x10x25 in. (250.6×255.5×637.4mm)		9.9x10x24 in. (250.6×255.5×610mm)		9.9x10.1x21.7 in. (250.6×255.5×550mm)	
Approx. Weight	59.5 lbs (27.0kg) ※		51.2 lbs (23.2kg) ※		47.4 lbs (21.5kg) ※	

※ Weight of lens body only (does not include servo module).  
\* M.O.D. = Minimum Object Distance.

## UHD DIGISUPER 86: Highlights

### High Zoom Ratio and Long Focal Length

While displaying performance that surpasses 4K, the lens has the high zoom ratio (86x) and long focal length (800 mm) desired by many in television production.

### Optical Performance That Goes Beyond 4K Even When Using the Built-in 2X Extender and Image Stabilizer

Thanks to the precision of its high-grade components and assembly, the lens achieves optical performance that goes beyond 4K even when the built-in 2x extender has been engaged. Also featured is an optical shift-type image stabilizing mechanism of Canon's highest grade, helping to achieve image stabilization performance commensurate with 4K.

### Applicability and Ease of Operation Ideally Suited to 4K Shooting

Since the lens achieves the zoom ratio, long focal length and size as well as the servo speed and stability required for the telecasting of live sports events and other applications, it facilitates the applicability and ease of operation ideally suited to 4K shooting.

### Optical Performance That Goes Beyond 4K

This lens has outstanding optical performance that goes beyond 4K resolution, all the way from screen center to the edges. Picture sharpness is maintained over the focal range of the lens and with changes in subject distance from the lens.





### Compatibility with HD Lens Systems

The lens enables the use of the same Canon standard controllers for zoom and focus as well as servo modules currently used by HD equipment. It comes with a 20-pin connector compatible with virtual units and that enables high-accuracy position information of the zoom, focus and iris to be read out.

# Broadcast Studio/Field Lenses

## HD 2/3"

	DIGISUPER 100AF <b>HD XS</b>		DIGISUPER 100 <b>HD XS</b>		DIGISUPER 95 TELE <b>HD XS</b>		DIGISUPER 95 <b>HD XS</b>	
Appearance								
	IMAGE STABILIZER		IMAGE STABILIZER		IMAGE STABILIZER		IMAGE STABILIZER	
Model Name	XJ100-9.3B AF		XJ100-9.3B		XJ95-12.4B		XJ95-8.6B	
Zoom Ratio	100x		100x		95x		95x	
Focal Length	9.3 ~ 930mm	18.6 ~ 1860mm (2.0x)	9.3 ~ 930mm	18.6 ~ 1860mm (2.0x)	12.4 ~ 1178mm	24.8 ~ 2356mm (2.0x)	8.6 ~ 820mm	17.2 ~ 1640mm (2.0x)
Maximum Relative Aperture	F1.7 (9.3 ~ 296mm) F4.7 (930mm)	F3.4 (18.6 ~ 592mm) F9.4 (1860mm)	F1.7 (9.3 ~ 296mm) F4.7 (930mm)	F3.4 (18.6 ~ 592mm) F9.4 (1860mm)	F2.5 (12.4 ~ 491mm) F6.0 (1178mm)	F5.0 (24.8 ~ 982mm) F12.0 (2356mm)	F1.7 (8.6 ~ 340mm) F4.1 (820mm)	F3.4 (17.2 ~ 680mm) F8.2 (1640mm)
Angular Field of View	54.6°×32.4° (9.3mm) 0.59°×0.33° (930mm)	28.9°×16.5° (18.6mm) 0.30°×0.17° (1860mm)	54.6°×32.4° (9.3mm) 0.59°×0.33° (930mm)	28.9°×16.5° (18.6mm) 0.30°×0.17° (1860mm)	42.3°×24.6° (12.4mm) 0.47°×0.26° (1178mm)	21.9°×12.4° (24.8mm) 0.23°×0.13° (2356mm)	58.3°×34.9° (8.6mm) 0.67°×0.38° (820mm)	31.2°×17.8° (17.2mm) 0.34°×0.19° (1640mm)
M.O.D.*	3.0m		3.0m		3.0m		3.0m	
Object Dimensions at M.O.D.*	276.4×155.5cm (9.3mm) 2.8×1.6cm (930mm)	138.2×77.8cm (18.6mm) 1.4×0.8cm (1860mm)	276.4×155.5cm (9.3mm) 2.8×1.6cm (930mm)	138.2×77.8cm (18.6mm) 1.4×0.8cm (1860mm)	209.5×117.8cm (12.4mm) 2.3×1.3cm (1178mm)	104.8×58.9cm (24.8mm) 1.2×0.7cm (2356mm)	298.1×167.7cm (8.6mm) 3.2×1.8cm (820mm)	149.1×83.9cm (17.2mm) 1.6×0.9cm (1640mm)
Approx. Size (WxHxL)	9.9x10x26 in. (250.6x255.5x661.5mm)		9.9x10x24 in. (250.6x255.5x610mm)		9.9x10x24 in. (250.6x255.5x610mm)		9.9x10x24 in. (250.6x255.5x610mm)	
Approx. Weight	59.3 lbs (26.8kg) ※		51.8 lbs (23.5kg) ※		51.1 lbs (23.2kg) ※		51.1 lbs (23.2kg) ※	

## HD 2/3"

	DIGISUPER 86AF <b>HD XS</b>		DIGISUPER 80 <b>HD XS</b>		DIGISUPER 76 <b>HD XS</b>		DIGISUPER 60 xs <b>HD XS</b>	
Appearance								
	IMAGE STABILIZER		IMAGE STABILIZER					
Model Name	XJ86-9.3B AF		XJ80-8.8B		XJ76-9B		XJ60-9B	
Zoom Ratio	86x		80x		76x		60x	
Focal Length	9.3 ~ 800mm	18.6 ~ 1600mm (2.0x)	8.8 ~ 710mm	17.6 ~ 1420mm (2.0x)	9.0 ~ 690mm	18.0 ~ 1380mm (2.0x)	9 ~ 540mm	18 ~ 1080mm (2.0x)
Maximum Relative Aperture	F1.7 (9.3 ~ 340mm) F4.0 (800mm)	F3.4 (18.6 ~ 680mm) F8.0 (1600mm)	F1.7 (8.8 ~ 340mm) F3.55 (710mm)	F3.4 (17.6 ~ 680mm) F7.1 (1420mm)	F1.7 (9.0 ~ 340mm) F3.45 (690mm)	F3.4 (18.0 ~ 680mm) F6.9 (1380mm)	F1.7 (9 ~ 306mm) F3.0 (540mm)	F3.4 (18 ~ 612mm) F6.0 (1080mm)
Angular Field of View	54.6°×32.4° (9.3mm) 0.69°×0.39° (800mm)	28.9°×16.5° (18.6mm) 0.34°×0.19° (1600mm)	57.2°×34.1° (8.8mm) 0.77°×0.44° (710mm)	30.5°×17.4° (17.6mm) 0.39°×0.22° (1420mm)	56.1°×33.4° (9mm) 0.80°×0.45° (690mm)	29.9°×17.1° (18.0mm) 0.40°×0.22° (1380mm)	56.1°×33.4° (9mm) 1.02°×0.57° (540mm)	29.9°×17.1° (18mm) 0.51°×0.29° (1080mm)
M.O.D.*	3.0m		3.0m		3.0m		2.8m	
Object Dimensions at M.O.D.*	276.4×155.5cm (9.3mm) 3.2×1.8cm (800mm)	138.2×77.8cm (18.6mm) 1.6×0.9cm (1600mm)	290.0×163.1cm (8.8mm) 3.7×2.1cm (710mm)	145.0×81.6cm (17.6mm) 1.9×1.1cm (1420mm)	282.4×158.9cm (9mm) 3.8×2.1cm (690mm)	141.2×79.5cm (18.0mm) 1.9×1.1cm (1380mm)	265.1×149.1cm (9mm) 4.5×2.5cm (540mm)	132.6×74.6cm (18.6mm) 2.3×1.3cm (1080mm)
Approx. Size (WxHxL)	9.9x10x26 in. (250.6x255.5x661.5mm)		9.9x10x24 in. (250.6x255.5x610mm)		9.9x10x24 in. (250.6x255.5x610mm)		9.9x10.1x21.6 in. (250.6x255.5x547.8mm)	
Approx. Weight	59.3 lbs (26.8kg) ※		51.1 lbs (23.2kg) ※		50.6 lbs (23.0kg) ※		43.8 lbs (19.9kg) ※	

## HD 2/3"

	DIGISUPER 27AF <b>HD XS</b>		DIGISUPER 27 <b>HD XS</b>		DIGISUPER 22 xs <b>HD XS</b>	
Appearance						
Model Name	XJ27-6.5B AF		XJ27-6.5B		XJ22-7.3B	
Zoom Ratio	27x		27x		22x	
Focal Length	6.5 ~ 180mm	13 ~ 360mm (2.0x)	6.5 ~ 180mm	13 ~ 360mm (2.0x)	7.3 ~ 161mm	14.6 ~ 322mm (2.0x)
Maximum Relative Aperture	F1.5 (6.5 ~ 123mm) F2.2 (180mm)	F3.0 (13 ~ 246mm) F4.4 (360mm)	F1.5 (6.5 ~ 123mm) F2.2 (180mm)	F3.0 (13 ~ 246mm) F4.4 (360mm)	F1.8 (7.3 ~ 111.5mm) F2.6 (161mm)	F3.6 (14.6 ~ 223mm) F5.2 (322mm)
Angular Field of View	72.9°×45.1° (6.5mm) 3.1°×1.7° (180mm)	40.5°×23.5° (13mm) 1.5°×0.9° (360mm)	72.9°×45.1° (6.5mm) 3.1°×1.7° (180mm)	40.5°×23.5° (13mm) 1.5°×0.9° (360mm)	66.7°×40.6° (7.3mm) 3.4°×1.9° (161mm)	36.4°×21.0° (14.6mm) 1.7°×1.0° (322mm)
M.O.D.*	0.6m		0.6m		0.8m	
Object Dimensions at M.O.D.*	106.1×59.7cm (6.5mm) 3.8×2.1cm (180mm)	53.1×29.9cm (13mm) 1.9×1.1cm (360mm)	106.1×59.7cm (6.5mm) 3.8×2.1cm (180mm)	53.1×29.9cm (13mm) 1.9×1.1cm (360mm)	118.1×66.4cm (7.3mm) 5.2×2.9cm (161mm)	59.1×33.2cm (14.6mm) 2.6×1.5cm (322mm)
Approx. Size (WxHxL)	9.9x10.1x22.3 in. (250.6x255.5x567mm)		9.9x10.1x21.7 in. (250.6x255.5x550mm)		6.5x6.9x13.2 in. (165x175x336mm)	
Approx. Weight	51.4 lbs (23.3kg) ※		48.3 lbs (21.9kg) ※		13.42 lbs (6.1kg)	

※ Weight of lens body only (does not include servo module).  
\* M.O.D. = Minimum Object Distance.

## DIGITAL UHD DIGISUPER/DIGISUPER Series

For:  
 UHD DIGISUPER 90 / UHD DIGISUPER 86 / UHD DIGISUPER 27 / DIGISUPER 100 / DIGISUPER 95 TELE / DIGISUPER 95 /  
 DIGISUPER 80 / DIGISUPER 76 / DIGISUPER 60xs / DIGISUPER 27

### FULL SERVO SYSTEM

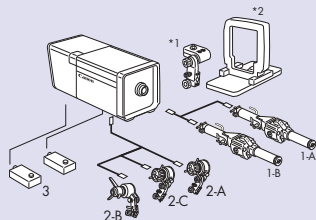

#### KIT DETAIL

No.	DESCRIPTION
1-A.	Zoom Demand ZDJ-D02 (Digital Servo)
1-B.	Zoom Demand ZDJ-P01 (Digital Servo)
2-A.	Focus Demand FDJ-D02 (Digital Servo)
2-B.	Focus Demand FDJ-D12 (Digital Servo)
2-C.	Focus Demand FDJ-P01 (Digital Servo)
3.	Servo Module SMJ-E01 (2pcs)

### SEMI-SERVO SYSTEM

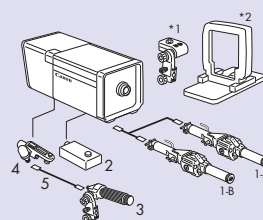

#### KIT DETAIL

No.	DESCRIPTION
1-A.	Zoom Demand ZDJ-D02 (Digital Servo)
1-B.	Zoom Demand ZDJ-P01 (Digital Servo)
2.	Servo Module SMJ-E01
3.	Flexible Focus Controller FFP-T61
4.	Flexible Module FMJ-702
5.	Flexible Cable 36"

For:  
 DIGISUPER 100AF / DIGISUPER 86AF /  
 DIGISUPER 27AF

### FULL SERVO SYSTEM

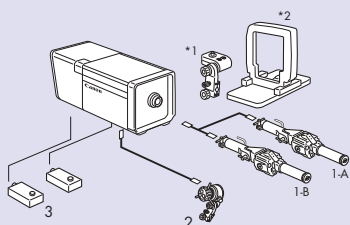

#### KIT DETAIL

No.	DESCRIPTION
1-A.	Zoom Demand ZDJ-D02 (Digital Servo)
1-B.	Zoom Demand ZDJ-P01 (Digital Servo)
2.	Focus Demand FDJ-P31 (Digital Servo)*3
3.	Servo Module SMJ-E01 (2pcs)

For:  
 All UHD DIGISUPER / DIGISUPER Lenses

### FULL MANUAL SYSTEM

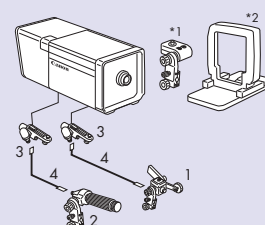

#### KIT DETAIL

No.	DESCRIPTION
1.	Flexible Zoom Controller FZP-T61
2.	Flexible Focus Controller FFP-T61
3.	Flexible Module FMJ-702 (2pcs)
4.	Flexible Cable 36" (2pcs)

\*1: Switch Box is optionally available. The equivalent switches are integrated into Zoom Demands. It is recommended to have the Switch Box with Full Manual System.

\*2: Lens Supporter is necessary for portable camera mounting. Some cameras need separate power supply for zoom and focus servo operation.

\*3: For DIGISUPER 100AF, DIGISUPER 86AF, and DIGISUPER 27AF, FDJ-P31 is necessary to control the AF function. FDJ-P41 is also available for left hand users.

• Zoom Demand and Focus Demand with Pre-set Box is also available.

• For detail information, please contact a Canon Sales Office.



## Control Accessories for Studio/Field Lenses

**For:**  
**DIGISUPER 22 xs**

The DIGISUPER 22 xs can be used with our current optional Studio/Field lens controllers as well as those for our ENG lenses. At the same time, the lens also offers compatibility with our Compact Studio/Field demands by use of a conversion cable.

### With Current ENG Demand (Standard)

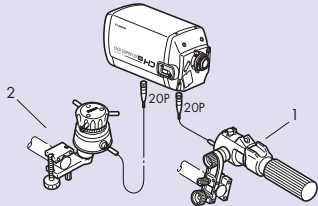

**KIT DETAIL**

No.	DESCRIPTION	MODEL #
1	Digital Zoom Demand	ZSD-300D
2	Digital Focus Demand	FPD-400D

### With Compact Field/Studio Demand

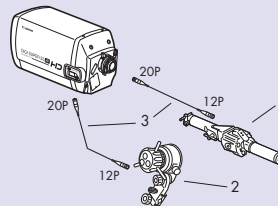

**KIT DETAIL**

No.	DESCRIPTION	MODEL #
1	Digital Zoom Demand	ZDJ-P01
2	Digital Focus Demand	FDJ-P01
3	Conversion Cable	BDC-21

### With Current Field/Studio Demand

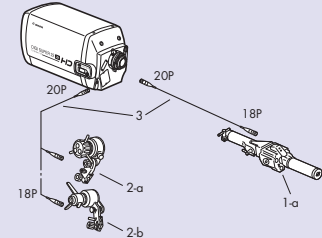

**KIT DETAIL**

No.	DESCRIPTION	MODEL #
1-a	Digital Zoom Demand	ZDJ-D02
2-a	Digital Focus Demand	FDJ-D02
2-b	Digital Focus Demand Propeller Type	FDJ-D12
3	Conversion Cable	BDC-11

The SUP-400 SUPPORTER is included as a standard component with the lens.

## Studio/Field Lenses Mount Compatibility

### To Use Camera Manufacturer's Original Mount Lens

Studio/Field lenses are made with mounts corresponding to each manufacturer's Studio/Field cameras. To make the lenses compatible with Portable Studio/Field Companion cameras, the correct lens Support System must be chosen from the following:

#### Standard HD Mount (BTA)

Panasonic, Ikegami, Hitachi, Thomson Grass Valley

Standard HD Mount Studio Camera Systems from Various Manufacturers

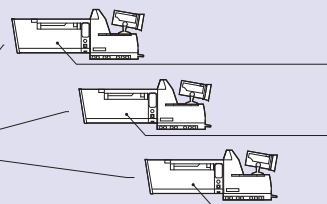

SUP-NP2S

2/3" Portable Companion Cameras with Standard HD Mount System

#### Sony

Sony 2/3" Studio Camera

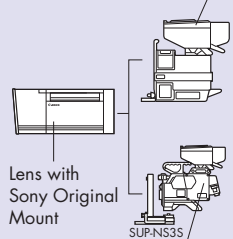

SUP-NS3S  
Sony System Companion Portable Camera

#### Thomson Grass Valley-SDTV

LDK 2/3" Studio Camera

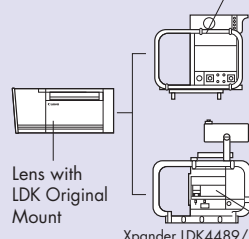

Xpander LDK4489/  
Super Xpander LDK4488  
Large Lens Adaptor

LDK System Companion Portable Camera

# Broadcast ENG/EFP HDXS Lenses

## 4K UHD 2/3"

	CJ20e×7.8B <b>UHD XS</b>		CJ12e×4.3B <b>UHD XS</b>	
Appearance				
Model Name	CJ20e×7.8B IASE S		CJ12e×4.3B IRSE S/IASE S	
Zoom Ratio	20×		12×	
Focal Length	7.8 ~ 156mm	15.6 ~ 312mm (2.0x)	4.3 ~ 52mm	8.6 ~ 104mm (2.0x)
Maximum Relative Aperture	F1.8 (7.8 ~ 108mm) F2.6 (156mm)	F3.6 (15.6 ~ 216mm) F5.2 (312mm)	F1.8 (4.3 ~ 40mm) F2.4 (52mm)	F3.6 (8.6 ~ 80mm) F4.8 (104mm)
Angular Field of View	63.2°×38.2° (7.8mm) 3.5°×2.0° (156mm)	34.2°×19.6° (15.6mm) 1.8°×1.0° (312mm)	96.3°×64.2° (4.3mm) 10.5°×5.9° (52mm)	58.3°×34.9° (8.6mm) 5.3°×3.0° (104mm)
M.O.D.* from Lens Front	0.8m		0.3m	
Object Dimensions at M.O.D.*	91.7×51.6cm (7.8mm) 4.8×2.7cm (156mm)	45.9×25.8cm (15.6mm) 2.4×1.4cm (312mm)	76.4×43.0cm (4.3mm) 6.0×3.4cm (52mm)	38.2×21.5cm (8.6mm) 3.0×1.7cm (104mm)
Approx. Size (WxHxL)	6.7x4.5x9.1 in. (169.9x114.4x230.0mm)		6.4x4.3x9.8 in. (163.5x108.0x247.8mm)	
Approx. Weight	4.81 lb (2.18kg)		4.63 lbs (2.1kg (IRSE S))	

\* M.O.D. = Minimum Object Distance.

## HD 2/3"

	HJ40e×14B <b>HD XS</b>		HJ40e×10B <b>HD XS</b>		HJ18e×28B <b>HD XS</b>	
Appearance						
Model Name	HJ40e×14B IASE-V H		HJ40e×10B IASE-V H		HJ18e×28B IASE S	
Zoom Ratio	40×		40×		18×	
Focal Length	14 ~ 560mm	28 ~ 1120mm (2.0x)	10 ~ 400mm	20 ~ 800mm (2.0x)	28 ~ 500mm	56 ~ 1000mm (2.0x)
Maximum Relative Aperture	F2.8 (14 ~ 307mm) F5.1 (560mm)	F5.6 (28 ~ 614mm) F10.2 (1120mm)	F2.0 (10 ~ 220mm) F3.65 (400mm)	F4.0 (20 ~ 440mm) F7.3 (800mm)	F2.8 (28 ~ 286mm) F4.9 (500mm)	F5.6 (56 ~ 572mm) F9.8 (1000mm)
Angular Field of View	37.8°×21.8° (14mm) 1.0°×0.6° (560mm)	19.4°×11.0° (28mm) 0.5°×0.3° (1120mm)	51.3°×30.2° (10mm) 1.4°×0.8° (400mm)	27.0°×15.4° (20mm) 0.7°×0.4° (800mm)	19.6°×11.1° (28mm) 1.1°×0.6° (500mm)	9.9°×5.6° (56mm) 0.6°×0.3° (1000mm)
M.O.D.* from Lens Front	2.8m		2.8m		2.2m	
Object Dimensions at M.O.D.*	177.1×99.5cm (14mm) 4.5×2.5cm (560mm)	88.6×49.8cm (28mm) 2.3×1.3cm (1120mm)	248.4×139.7cm (10mm) 6.2×3.5cm (400mm)	124.2×69.9cm (20mm) 3.1×1.8cm (800mm)	71.1×40.0cm (28mm) 4.1×2.3cm (500mm)	35.6×20.0cm (56mm) 2.1×1.2cm (1000mm)
Approx. Size (WxHxL)	6.6x5.2x14 in. (167.5x133.0x355.5mm)		6.6x5.2x13.2 in. (167.5x133.0x335.4mm)		6.9x4.9x10.6 in. (176.2x124.5x268.3mm)	
Approx. Weight	12.2 lbs (5.55 kg)		12.1 lbs (5.5 kg)		5.65 lbs (2.56kg)	

\* M.O.D. = Minimum Object Distance.

# Broadcast ENG/EFP HDxS Lenses

## HD 2/3"

	HJ24x7.5B 		HJ21x7.5B 		HJ18x7.6B 	
Appearance						
Model Name	HJ24x7.5B IRSE S/IASE S		HJ21x7.5B IASE S		HJ18x7.6B IRSE S/IASE S	
Zoom Ratio	24x		21x		18x	
Focal Length	7.5 - 180mm	15 - 360mm (2.0x)	7.5 - 158mm	15 - 316mm (2.0x)	7.6 - 137mm	15.2 - 274mm
Maximum Relative Aperture	F1.8 (7.5 - 120mm) F2.7 (180mm)	F3.6 (15 - 240mm) F5.4 (360mm)	F1.9 (7.5 - 116mm) F2.6 (158mm)	F3.8 (15 - 232mm) F5.2 (316mm)	F1.8 (7.6 - 103mm) F2.4 (137mm)	F3.6 (15.2 - 206mm) F4.8 (274mm)
Angular Field of View	65.2°×39.6° (7.5mm) 3.1°×1.7° (180mm)	35.5°×20.4° (15mm) 1.5°×0.9° (360mm)	65.2°×39.6° (7.5mm) 3.5°×2.0° (158mm)	35.5°×20.4° (15mm) 1.7°×1.0° (316mm)	64.6°×39.1° (7.6mm) 4.0°×2.3° (137mm)	35.1°×20.1° (15.2mm) 2.0°×1.1° (274mm)
M.O.D.* from Lens Front	0.80m		0.85m		0.56m	
Object Dimensions at M.O.D.*	96.0×54.0cm (7.5mm) 4.1×2.3cm (180mm)	48.0×27.0cm (15mm) 2.1×1.2cm (360mm)	120.4×67.7cm (7.5mm) 5.6×3.2cm (158mm)	60.2×33.9cm (15mm) 2.8×1.6cm (316mm)	65.5×36.8cm (7.6mm) 3.8×2.1cm (137mm)	32.8×18.4cm (15.2mm) 1.9×1.1cm (274mm)
Approx. Size (WxHxL)	6.5x4.3x8.7 in. (164.6x109.1x221.4mm)		6.9x4.8x10.2 in. (175.2x122x260.1mm)		6.5x4.1x8.1 in. (165.1x105.0x206.2mm)	
Approx. Weight	3.92 lbs (1.78kg (IRSE S))		5.94 lbs (2.69kg)		3.48 lbs (1.58kg (IRSE S))	

\* M.O.D. = Minimum Object Distance.

## HD 2/3"

	HJ17x6.2B 		HJ14x4.3B 		HJ15x8.5B  Optical Image Stabilizer Installed	
Appearance						
Model Name	HJ17x6.2B IRSE S/IASE S		HJ14x4.3B IRSE S/IASE S		HJ15x8.5B KRSE-V S	
Zoom Ratio	17x		14x		15x	
Focal Length	6.2 - 106mm	12.4 - 212mm (2.0x)	4.3 - 60mm	8.6 - 120mm (2.0x)	8.5 - 128mm	
Maximum Relative Aperture	F1.8 (6.2 - 65.8mm) F2.9 (106mm)	F3.6 (12.4 - 131.6mm) F5.8 (212mm)	F1.8 (4.3 - 40mm) F2.7 (60mm)	F3.6 (8.6 - 80mm) F5.4 (120mm)	F2.5 (8.5 - 68mm) F4.7 (128mm)	
Angular Field of View	75.5°×47.1° (6.2mm) 5.2°×2.9° (106mm)	42.3°×24.6° (12.4mm) 2.6°×1.5° (212mm)	96.3°×64.2° (4.3mm) 9.1°×5.2° (60mm)	58.3°×34.9° (8.6mm) 4.6°×2.6° (120mm)	58.9°×35.2° (8.5mm) 4.3°×2.4° (128mm)	
M.O.D.* from Lens Front	0.4m		0.3m		0.8m	
Object Dimensions at M.O.D.*	73.3×41.2cm (6.2mm) 4.1×2.3cm (106mm)	36.7×20.6cm (12.4mm) 2.1×1.2cm (212mm)	76.4×43.0cm (4.3mm) 5.2×2.9cm (60mm)	38.2×21.5cm (8.6mm) 2.6×1.5cm (120mm)	95.8×53.9cm (8.5mm) 6.4×3.6cm (128mm)	
Approx. Size (WxHxL)	6.5x4.4x9.5 in. (165.0x111.8x240.5mm)		6.4x4.4x9.8 in. (163.5x111.8x247.8mm)		6.7x4.7x9.4 in. (170.2x119.4x239.1mm)	
Approx. Weight	4.34 lbs (1.97kg (IRSE S))		4.39 lbs (1.99kg (IRSE S))		4.37 lbs (1.99kg)	

\* M.O.D. = Minimum Object Distance.

# HDGc Lenses

## HD 2/3"

Appearance	<b>KJ22ex7.6B</b> 		<b>KJ17ex7.7B</b> 		<b>KJ10ex4.5B</b> 	
	Model Name: KJ22ex7.6B IRSE/IASES		Model Name: KJ17ex7.7B IRSE S/IASES S		Model Name: KJ10ex4.5B IRSE S/IASES A	
Zoom Ratio	22x		17x		10x	
Focal Length	7.6-168mm	15.2-336mm (2.0x)	7.7-131mm	15.4-262mm (2.0x)	4.5-45mm	9-90mm (2.0x)
Maximum Relative Aperture	1:1.8 at 7.6-116.3mm 1:2.6 at 168mm	1:3.6 at 15.2-232.6mm 1:5.2 at 336mm (2.0x)	1:1.8 at 7.7-102.5mm 1:2.3 at 131mm	1:3.6 at 15.4-205mm 1:4.6 at 262mm	1:1.8 at 4.5-34.5mm 1:2.35 at 45mm	1:3.6 at 9-68.9mm 1:4.7 at 90mm
Angular Field of View	64.6°x39.1° at 7.6mm 3.3°x1.8° at 168mm	35.1°x20.1° at 15.2mm 1.6°x0.9° at 336mm	63.9°x38.6° at 7.7mm 4.2°x2.36° at 131mm	34.6°x19.9° at 15.4mm 2.1°x1.18° at 262mm	93.7°x61.9° at 4.5mm 12.2°x6.9° at 45mm	56.1°x33.4° at 9mm 6.1°x3.4° at 90mm
M.O.D.* from Lens Front	0.8m		0.6m		0.3m	
Object Dimensions at M.O.D.*	95.0x53.4cm at 7.6mm 4.4x2.5cm at 168mm	47.5x26.7cm at 15.2mm 2.2x1.3cm at 336mm	68.5x38.5cm at 7.7mm 4.2x2.4cm at 131mm	34.3x19.3cm at 15.4mm 2.1x1.2cm at 262mm	74.1x41.7cm at 4.5mm 6.4x3.6cm at 45mm	37.0x20.8cm at 9mm 3.2x1.8cm at 90mm
Approx. Size (WxHxL)	6.5x4.4x8.6 in. (164.7x111.8x218.6mm)		6.3x4.2x7.8 in. (159.3x106.6x197.8mm)		6.6x4.4x9.4 in. (168.2x111.8x237.7mm)	
Approx. Weight (IRSE/IASE)	4.0 lbs (1.82kg)/4.19 lbs (1.90kg)		3.26 lbs (1.48kg)/3.44 lbs (1.56kg)		4.04 lbs (1.83kg)/4.22 lbs (1.91kg)	

## HD 2/3"

Appearance	<b>KJ20x8.2B</b> 		<b>KJ20x8.2B</b> 		<b>KJ13x6B</b> 	
	Model Name: KJ20x8.2B IRSD		Model Name: KJ20x8.2B KRSD		Model Name: KJ13x6B KRSD	
Zoom Ratio	20x		20x		13x	
Focal Length	8.2-164mm	16.4-328mm (2.0x)	8.2-164mm	6-78mm		
Maximum Relative Aperture	1:1.9 at 8.2-115.4mm 1:2.7 at 164mm	1:3.8 at 16.4-230.8mm 1:5.4 at 328mm	1:1.9 at 8.2-115.4mm 1:2.7 at 164mm	1:2.0 at 6-58mm 1:2.7 at 78mm		
Angular Field of View	60.7°x36.5° at 8.2mm 3.4°x1.9° at 164mm	32.6°x18.7° at 16.4mm 1.7°x0.9° at 328mm	60.7°x36.5° at 8.2mm 3.4°x1.9° at 164mm	77.3°x48.5° at 6mm 7.0°x4.0° at 78mm		
M.O.D.* from Lens Front	0.9m		0.9m		0.4m	
Object Dimensions at M.O.D.*	98.2x55.2cm at 8.2mm 5.0x2.8cm at 164mm	49.1x27.6cm at 16.4mm 2.5x1.4cm at 328mm	98.2x55.2cm at 8.2mm 5.0x2.8cm at 164mm	74.3x41.8cm at 6mm 5.4x3.0cm at 78mm		
Approx. Size (WxHxL)	6.4x4.1x8.2 in. (163.3x104.1x208.0mm)		6.4x4x7.2 in. (163.3x101.6x181.8mm)		6.5x4.1x8.3 in. (165.4x104.1x211.7mm)	
Approx. Weight	3.13 lbs (1.42kg)		2.76 lbs (1.25kg)		3.51 lbs (1.59kg)	

## HD 1/2", 1/3"

Appearance	<b>KH20x6.4</b> 	<b>KH13x4.5</b> 	<b>KT17ex4.3B</b> 	<b>KT20x5B</b> 
	Model Name: KH20x6.4 KRSD SY14	Model Name: KH13x4.5 KRSD SY14	Model Name: KT17ex4.3B IRSE	Model Name: KT20x5B KRSD A
Zoom Ratio	20x	13x	17x	20x
Focal Length	6.4-128mm	4.5-59mm	4.3-73mm	5-100mm
Maximum Relative Aperture	1:1.4 at 6.4-89.6mm 1:2.0 at 128mm	1:1.5 at 4.5-44mm 1:2.0 at 59mm	1:1.4 at 4.3-73mm	1:1.4 at 5.0-90.3mm 1:1.55 at 100mm
Angular Field of View	57.1°x34.1° at 6.4mm 3.1°x1.8° at 128mm	75.7°x46.9° at 4.5mm 6.8°x3.8° at 59mm	62.6°x37.7° at 4.3mm 4.1°x2.3° at 73mm	55.2°x32.8° at 5mm 3.0°x1.7° at 100mm
M.O.D.* from Lens Front	0.9m	0.4m	0.6m	0.9m
Object Dimensions at M.O.D.*	89.8x50.5cm at 6.4mm 4.6x2.6cm at 128mm	73.4x41.3cm at 4.5mm 5.4x3.0cm at 59mm	66.9x37.6cm at 4.3mm 4.1x2.3cm at 73mm	88.1x49.6cm at 5.0mm 4.5x2.5cm at 100mm
Approx. Size (WxHxL)	6.4x4x7.2 in. (163.3x101.6x182.5mm)	6.5x4.1x8.5 in. (165.4x104.1x215.3mm)	6.3x4.2x7.8 in. (159.3x106.6x197.3mm)	6.4x4.1x6.7 in. (163.3x104.1x171.2mm)
Approx. Weight	2.8 lbs (1.27kg)	3.51 lbs (1.59kg)	3.26 lbs (1.48kg)	2.62 lbs (1.19kg)

\* M.O.D. = Minimum Object Distance.



## Remote Control Lenses

## HD 2/3"

HDTV	HJ18ex28B	HJ24ex7.5B	HJ18ex7.6B*1	HJ14ex4.3B
Appearance				
Model Name	HJ18ex28B ITS-ME	HJ24ex7.5B ITS-ME	HJ18ex7.6B ITS-ME*1	HJ14ex4.3B ITS-ME
Zoom Ratio	18x	24x	18x	14x
Image Size	2/3"	2/3"	2/3"	2/3"
Built-in Extender	2.0x	2.0x	2.0x	2.0x
Range of Focal Length (with Extender)	28-500mm 56-1000mm (2.0x)	7.5-180mm 15.0-360mm (2.0x)	7.6-137mm 15.2-274mm (2.0x)	4.3-60mm 8.6-120mm (2.0x)

## HD 2/3"

HDTV	KJ17ex7.7B	KJ22ex7.6B
Appearance		
Model Name	KJ17ex7.7B ITS-ME	KJ22ex7.6B ITS-ME
Zoom Ratio	17x	22x
Image Size	2/3"	2/3"
Built-in Extender	2.0x	2.0x
Range of Focal Length (with Extender)	7.7-131mm 15.4-262mm (2.0x)	7.6-168mm 15.2-336mm (2.0x)

	HD 2/3"	HD 1/2"	HD 1/3"
HDTV	KJ20x8.2B	KH20x6.4	KT20x5B
Appearance			
Model Name	KJ20x8.2B KTS	KH20x6.4 KTS*2	KT20x5B KTS
Zoom Ratio	20x	20x	20x
Image Size	2/3"	1/2"	1/3"
Built-in Extender	N/A	N/A	N/A
Range of Focal Length	8.2-164mm	6.4-128mm	5-100mm

\*2: Specifically designed for Sony HDC-X300/X310.

# Pro Video Lens Optical Accessories

## Adaptor Type Converters/Attachments



CATEGORY	MODEL	CJ12e×4.3B HJ14e×4.3B KJ10e×4.5B HJ18e×28B HJ40e×14B HJ40e×10B HJ21e×7.5B	KJ13×6B KH13×4.5	HJ15e×8.5B	CJ20e×7.8B KJ22e×7.6B HJ24e×7.5B HJ17e×6.2B	KJ20×8.2B KT17e×4.3B KJ17e×7.7B KT20×5B KH20×6.4 HJ18e×7.6B
TELESIDE CONVERTER *1	T15HG				●	●
WIDE CONVERTER *1	W80HD				●	
	W80HG					●
WIDE ATTACHMENT *1	WA75HG				● *2	●
FISHEYE ATTACHMENT *1	FEA60HG				●	●
ADAPTER RING	ACC-85 III					●
	ACC-98 II				●	
CLOSE-UP LENS	82CL-UP800H			●		●
	82CL-UP1300H			●		●
	105CL-UP900H					
	105CL-UP800HD				●	
	105CL-UP800HG				●	
UV FILTER	UV / 82			●		●
	UV / 94				●	
	UV / 105		●		●	
	UV / 127	●				
CLEAR FILTER	CL / 127	●				
POLARIZATION FILTER	PL / 82			●		●
	PL / 105		●		●	
	PL / 127	●				

\*1: An adaptor ring is necessary to attach it to the lens. \*2: Can not be used with CJ 20ex.

• The number of each filter type name, indicates the screw diameter. Screw pitch: screw diameter 82 mm = 0.75 mm, thread diameter 127 mm = 0.75 mm, thread diameter other than the left = 1.00 mm.

## Mount Converters for Different Image Format Size Cameras

Canon offers a variety of Mount Converters to be used between a lens and a camera of different image format sizes. Each converter will extend the effective Angular Field of View of the associated lens according to the Shift Ratio listed below.

	Converter	Image Size Conversion			Electronic Conversion
		Lens <sup>*3</sup>	Camera	Shift Ratio to Telephoto Side	
	LO-32BMT	2/3" B4 Mount	1/2" Sony <sup>*4</sup>	Approx. 1.4x	N/A
	LCV-40B	2/3" B4 Mount	1/2 Standard Mount <sup>*5</sup>	Approx. 1.4x	N/A
	LCV-42T	2/3" B4 Mount	1/3" Standard Mount	Approx. 1.8x	N/A
	LCV-41E	2/3" B4 Mount	Sony PMW-EX3	Approx. 1.4x	Lens Cable (12 pin) EX3 Hot Shoe (14 pin)
	LCV-20E	1/2" <sup>*6</sup>	Sony PMW-EX3	N/A	Lens Cable (12 pin) EX3 Hot Shoe (14 pin)

\*3: The converters are to be used with lenses weighing less than 4.4 lbs (2.0kg). \*4: Sony's Hot Shoe mount camera, excluding PMW-EX3.

\*5: 1/2" Camera of standard type mount (Panasonic, JVC, Grass Valley). \*6: Only applicable to KH10ex/KH16ex/KH21ex. The other 1/2" mount lenses are not available.

## Pro Video Lens Optical Accessories

### Converter/Attachments

#### TELE-SIDE CONVERTER



- The use of the telephoto converter would shift the focal length of a lens with a factor of 1.5x.
- F No. of the original lens is not affected.
- Only the telephoto side of the lens can be used. The picture corners are eclipsed at wide angle.
- The minimum object distance becomes 2.25x that of the original lens.

#### CHANGE IN FOCAL LENGTH

Model	M.O.D.	Eclipse Point
HJ24ex7.5B	1.8m	f:100mm
KJ17ex7.7B	1.35m	f:60mm

#### WIDE CONVERTER



- The wide converter W80/W80Y-85 would shift the focal length of a lens with a factor of 0.8x.
- F No. of the original lens is not affected.
- The minimum object distance becomes 0.64x with the W80/W80Y-85.

#### CHANGE IN FOCAL LENGTH

Model	Master Lens	With Wide Converter
HJ24ex7.5B	7.5-180mm	6.0-144mm
KJ17ex7.7B	7.7-131mm	6.2-104.8mm

#### FISH-EYE ATTACHMENT



- The zoom lens becomes a fish-eye fixed focal length lens (distorted image) with the fish-eye attachment.
- The use of a fish-eye attachment would shift the focal length of a lens with a factor of 0.6x.
- Focus is adjusted by use of the macro lever.

#### CHANGE IN FOCAL LENGTH

Model	Master Lens	With Fish-Eye Attachment
HJ24ex7.5B	7.5-180mm	4.5mm
KJ17ex7.7B	7.7-131mm	4.6mm

#### WIDE ATTACHMENT



- The zoom lens becomes a wider fixed focal length lens with the wide attachment.
- The use of the wide attachment would shift the focal length of a lens with a factor of 0.75x.
- Focus is adjusted by use of the macro lever.

#### CHANGE IN FOCAL LENGTH

Model	Master Lens	With Wide Attachment
HJ24ex7.5B	7.5-180mm	5.6mm
KJ17ex7.7B	7.7-131mm	5.8mm

#### POLARIZED LIGHT FILTER



- Used to intercept light reflected from the surface of water or glass.
- The polarizer is threaded on to a lens hood.

### Extenders



- The X2.0-B4 extender mounts in between a camera and lens to magnify an image.
- The extender doubles the focal length of the master lens and doubles the F-number.

Model	Applicable Lenses
X2.0-B4	Applicable to all B4 type mount Canon 2/3" lenses.

## Pro-Video Lens Optical Accessories

### Close-Up Lenses



- A close-up lens is used to shorten the M.O.D.\* of the master lens for close-up shooting.
- The maximum object distance becomes the focal length of the close-up lens.
- The minimum object distance is calculated by the following formula:

$$\text{New minimum object distance} = fc \times S / (fc + S)$$

fc = Focal length of the close-up lens

S = M.O.D.\* of the master lens

### Imaging range for KJ17ex7.7B with close-up lenses

KJ17ex7.7B (16:9)	82CL-UP800H				82CL-UP1300H			
	Tele end : 131mm		Wide end : 7.7mm		Tele end : 131mm		Wide end : 7.7mm	
	Focusing Scale (mm)	∞	0.6	∞	0.6	∞	0.6	∞
Object Distance (mm)	800	343	800	343	1300	411	1300	411
Object Dimensions (mm)	58x33	24x14	989x556	376x212	95x53	29x16	1634x919	455x256

Model	Applicable Lenses
82CL-UP800H	KJ17ex7.7B, KJ20x8.2B, KH20x6.4, KT17ex4.3B, KT20x5
82CL-UP1300H	KJ17ex7.7B, KJ20x8.2B, KH20x6.4, KT17ex4.3B, KT20x5
105CL-UP900H	KJ22ex7.6B <sup>u</sup>
105CL-UP800HG	CJ20ex7.8B, HJ24ex7.5B, KJ22ex7.6B <sup>u</sup>

\*M.O.D. = Minimum Object Distance.

∞ = Infinite

<sup>u</sup>The HD quality accessories offer higher optical performance.

## Broadcast ENG/EFP Lens Accessories

### Compatible Zoom/Focus Control List

OPERATION	CATEGORY	MODEL	HJ18x28B HJ40e×14B HJ40e×10B	HJ15e×8.5B	CJ20e×7.8B CJ12e×4.3B KJ22e×7.6B HJ24e×7.5B KJ17e×7.7B HJ21e×7.5B KJ10e×4.5B HJ18e×7.6B KT17e×4.3B HJ17e×6.2B HJ14e×4.3B	KJ20×8.2B KT20×5B KH20×6.4
FOCUS	FOCUS DEMAND	FPD-400D	●	● (IAS) <sup>*1</sup>	●	● <sup>*1</sup>
	DRIVE UNIT	FPM-77				●
		FPM-420D		● (IRS)	● (IRS)	
	FLEX CONTROLLER	FFC-200	●	●	● <sup>*2</sup>	●
		FFC-15				●
	FLEXIBLE CABLE (32 INCHES)	FC-40	●	●	● <sup>*2</sup>	●
	OUTLET	FFM-100		●	● <sup>*2</sup>	
FM-12					●	
FFM-300		●				
ZOOM	ZOOM DEMAND	ZSD-300D	●	● <sup>*1</sup>	●	
	PROVIDEO ZOOM	ZSD-15MII				●
	SERVO GRIP	ZSG-200M	●	●	●	●

\* 1: A unit that can be attached using a conversion cable.

\* 2: It is not recommended for 4K shooting.



## Broadcast ENG/EFP Lens Accessories

### Focus Controller



### Zoom Controller



■ Conversion Cable is Necessary When Using with the Following Combinations

Model Name	Applicable Lens	Adapter Cable	Lens Side Pin#	Control Side Pin#
FPM-420D	Analog Drive Lens	CC-1220	12	20
FPD-400D		CC-0620	6	20
ZSD-300D		CC-0820	8	20

## Control Accessories for Digital Drive ENG/EFP Lenses

KJ22ex7.6B / KJ17ex7.7B / KJ10ex4.5B / KH10ex3.6 / KT17ex4.3B / HJ14ex4.3B / HJ15ex8.5B KRSE S / HJ17ex6.2B / HJ18ex7.6B / HJ18ex28B / HJ21ex7.5B / HJ24ex7.5B / HJ40ex10B / HJ40ex14B / CJ12ex4.3B / CJ20ex7.8B

■ Recommended Kit Configurations

**MS-210D**  
for all listed IRSE S/KRSE S lenses

SEMI-SERVO KIT

FFM-100  
FC-40  
FFC-200  
ZSD-300D

HXS  
HGC

**SS-41-D**  
for all listed IRSE S/KRSE S lenses

FULL SERVO KIT

FPM-420D  
FPD-400D  
ZSD-300D

HXS  
HGC

**SS-41-IASD**  
for all listed IASE S lenses

FULL SERVO KIT

FPD-400D  
ZSD-300D

HXS  
HGC  
DIGITAL DRIVE  
DD

**SS-42-IAS**  
for all listed IASE S lenses

FULL SERVO KIT

FPD-400D  
EC-80  
CR-10  
ZSG-200M

HXS  
HGC  
DIGITAL DRIVE  
DD

# DIGITAL Control Accessories of Digital Drive ENG/EFP Lenses

## Applicable Component Detail

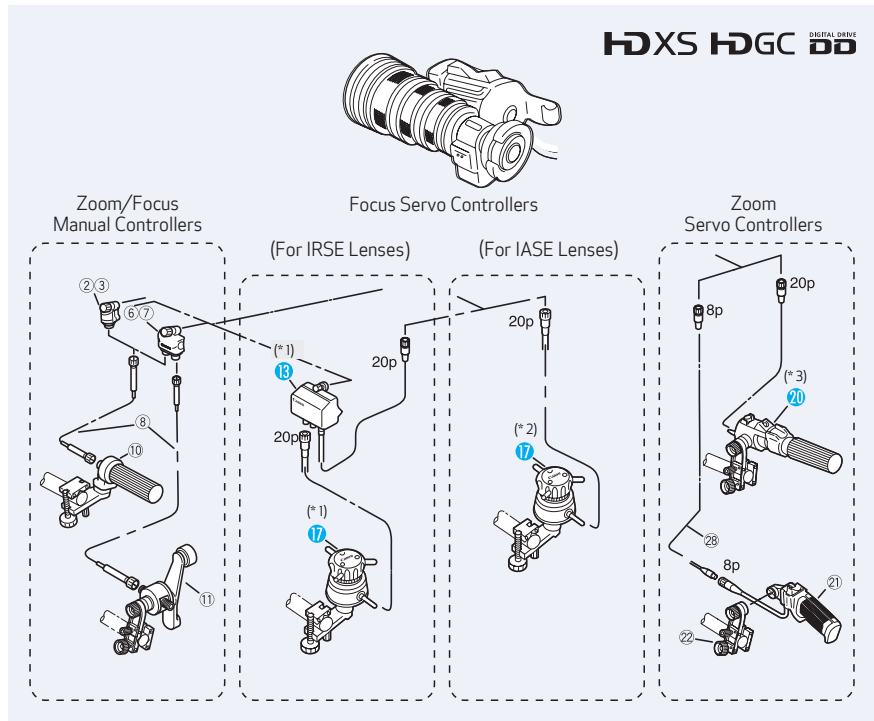

#	UNIT	DESCRIPTION
2	FFM-100	Flex Focus Module
3	FFM-300	Flex Focus Module
6	FFM-200	Flex Dual Module
7	FFM-400 <sup>*1</sup>	Flex Dual Module
8	FC-40	Flex Cable
10	FFC-200	Flex Focus Controller
11	FZC-100 <sup>*4</sup>	Flex Zoom Controller
13	FPM-420D	Focus Positional Servo Module
17	FPD-400D	Focus Positional Demand
20	ZSD-300D	Zoom Demand
21	ZSG-200M	Zoom Servo Grip
22	CR-10	Clamper
28	EC-80	Zoom Extension Cable (8P)

- \*1: FFM-400, FPD-400, FPM-420 and ZSD-300A/M are discontinued.
  - \*2: Analog FPD-400 is also applicable, however, CC-2006 conversion cable is necessary to connect between IASD/IASE Digital Drive Lens and FPD-400.
  - \*3: Analog ZSD-300A/M is also applicable.
  - \*4: FPD-400, FZC-100 and ZSD-300A/M are discontinued models and are no longer available from Canon.
  - \*5: Consult Product Admin for more information.
- The controllers support the new DD functions.

## Applicable Kit Detail

### For IRSE Type Lenses

	Kit Name	Zoom		Focus	
		System	Component	System	Component
Zoom Servo Only	(ZR-1D)	ZR-1D	20	—	—
	—	ZR-2(A)	21, 22, 28	—	—
Semi-Servo	MS-210D	ZR-1D	20	FR-2	2, 8, 10
	MS-220	ZR-2(A)	21, 22, 28	FR-2	2, 8, 10
Full Servo	SS-41-D	ZR-1D	20	FPS-4D	13, 17
Full Manual	—	FZC-1	6, 8, 11	FR-2 (w/o 2)	8, 10

### For HJ40ex14B and HJ40ex10B

	Kit Name	Zoom		Focus	
		System	Component	System	Component
Zoom Servo Only	—	ZR-1D	20	—	—
	—	ZR-2(A)	21, 22, 28	—	—
Semi-Servo	—	ZR-1D	20	FR-2	3, 8, 10
	—	ZR-2(A)	21, 22, 28	FR-2	3, 8, 10
Full Servo	SS-41-IASD	ZR-1D	20	FPS-4D	17
	SS-42-IASD	ZR-2(A)	21, 22, 28	FPS-4D	17
Full Manual	—	FZC-1	6, 8, 11	FR-2 (w/o 2)	8, 10

### For IASE Type Lenses (Except HJ40ex)

	Kit Name	Zoom		Focus	
		System	Component	System	Component
Zoom Servo Only	(ZR-1D)	ZR-1D	20	—	—
	—	ZR-2(A)	21, 22, 28	—	—
Semi-Servo	MS-210D	ZR-1D	20	FR-2	2, 8, 10
	MS-220	ZR-2(A)	21, 22, 28	FR-2	2, 8, 10
Full Servo	SS-41-IASD	ZR-1D	20	FPS-4D	17
	SS-42-IASD	ZR-2(A)	21, 22, 28	FPS-4D	17
Full Manual	—	FZC-1	6, 8, 11	FR-2 (w/o 2)	8, 10

Recommended kit configuration.

# ANALOG Control Accessories for Analog Drive HDgc<sup>(\*)</sup> Lenses

## Recommended Kit Configuration

### MS-15 SEMI-SERVO KIT

for all Pro-video ENG lenses

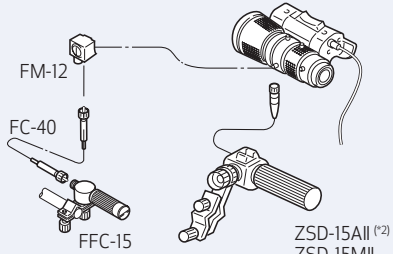

### MS-22 SEMI-SERVO KIT

for all Pro-video ENG lenses

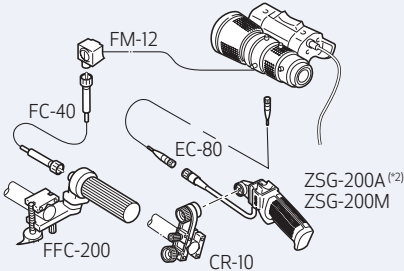

### MS-21D SEMI-SERVO KIT

for all Pro-video ENG lenses

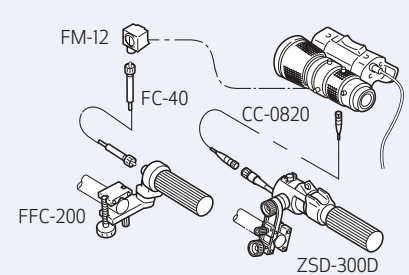

\*1: HDgc Lenses on pages 29 and 30 (excluding KT17ex4.3B).

\*2: "A" or "M" type demands depend upon camera. Type "A" demands are no longer available from Canon.

## Applicable Component Detail

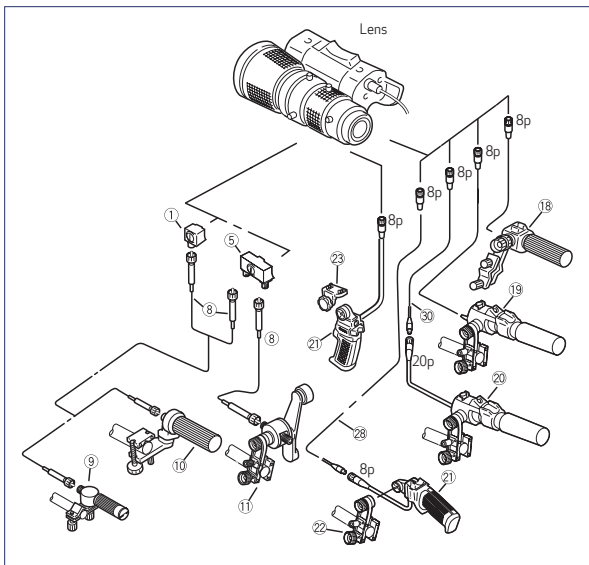

#	UNIT	DESCRIPTION
①	FM-12	Flex Focus Module
⑤	FM-70	Flex Dual Module
⑧	FC-40	Flex Cable
⑨	FFC-15	Flex Focus Controller
⑩	FFC-200	Flex Focus Controller
⑪	FZC-100	Flex Zoom Controller
⑯	ZSD-15A II / M II	Zoom Demand <sup>3</sup> A (A or M types, depends on applicable camera) M
⑰	ZSD-300A/M	Zoom Demand <sup>3</sup> A (A or M types, depends on applicable camera) M
⑱	ZSD-300D	Zoom Demand
⑲	ZSG-200A/M	Zoom Servo Grip <sup>3</sup> A (A or M types, depends on applicable camera) M
⑳	CR-10	Clamper
㉑	GA-70	Grip Adapter
㉒	EC-80	Zoom Extension Cable (8P)
㉘	CC-0820	Conv. Cable (8pM-20pF)

\*FM-70, FZC-100, and GA-70 are discontinued.

\*3: ZSD-15A II, ZSD-300A/M, ZSG-200A, and FPD-400 is not available from Canon stock.

\*5: Consult Product Admin for more information.

## Applicable Kit Detail

	Kit Name	Zoom		Focus	
		System	Component	System	Component
Zoom Servo Only	—	ZSD-15	16	—	—
	—	ZR-1	17	—	—
	—	ZR-2(A)	19, 20, 26	—	—
	—	ZR-2(B)	19, 21*	—	—
Semi-Servo	MS-15	ZSD-15	16**	FRC-15	1, 8, 9**
	MS-21	ZR-1	17	FR-2	1, 8, 10
	MS-21D	ZR-1D	18, 28	FR-2	1, 8, 10
	MS-22	ZR-2(A)	19, 20, 26	FR-2	1, 8, 10
Full Manual	FZC-1	FZC-1	5*, 8, 11	FR-2(w/o 1)	8, 10

\* ⑤ & ㉑ are not applicable to YH14x7.3 and YH16x7.

\*\*In USA, ⑯ and ⑨ are available only as MS-15 kit configuration and not as individual products.

Recommended kit configuration.

# Cinema Lens Lineup



## ZOOM Series

Canon Cinema Zoom Lenses offer superb optical performance that exceeds 4K resolution and are designed to meet the most demanding of high-end productions. They combine fluorite and aspherical lens elements, the latest in advanced optical coatings and superior lens designs for outstanding edge-to-edge image quality.



## COMPACT ZOOM Series

Canon Cinema Compact Zoom Lenses offer 4K resolution in form factors that enable more flexible, less intrusive shooting. They also feature a constant T-number (2.8) throughout their zoom ranges as well as the latest advancements in lens design for outstanding image quality and minimal distortion.



## PRIME Series

The flexible series of Canon Cinema Prime Lenses offers spectacular 4K-image quality and a full-frame image circle, in lightweight, compact designs. They feature high optical speed, produce remarkably sharp 4K images and superb contrast, and maintain tightly controlled focus breathing and geometric distortion. Low T-numbers enable better low-light shooting.



## CINE-SERVO Series

Canon CINE-SERVO Lenses support cinema production as well as 4K content creation for broadcast. Featuring a servo drive unit, they can be ideal for shooting scenarios where mobility is key.



## COMPACT-SERVO Series

COMPACT-SERVO lenses combine the benefits of compact size and light weight for outstanding mobility. Designed to shoot video, these lenses combine the functionality of our EF lenses with the video shooting features of our Cinema lenses.



## ZOOM Lens Series

 P. 35

CN-E14.5-60mm T2.6 L S  
CN-E14.5-60mm T2.6 L SP



CN-E30-300mm T2.95-3.7 L S  
CN-E30-300mm T2.95-3.7 L SP



## COMPACT ZOOM Lens Series

 P. 35

CN-E15.5-47mm T2.8 L S  
CN-E15.5-47mm T2.8 L SP



CN-E30-105mm T2.8 L S  
CN-E30-105mm T2.8 L SP



## PRIME Lens Series

 P. 36

CN-E14mm T3.1 L F



CN-E24mm T1.5 L F



CN-E35mm T1.5 L F



CN-E50mm T1.3 L F



CN-E85mm T1.3 L F



CN-E135mm T2.2



## CINE-SERVO Lens Series

 P. 37

CN7×17 KAS S/E1  
CN7×17 KAS S/P1



CN20×50 IAS H/E1  
CN20×50 IAS H/P1



## COMPACT-SERVO Lens Series

 P. 38

CN-E18-80mm T4.4 L IS KAS S



CN-E70-200mm T4.4 L IS KAS S



ZSG-C10



# MEETING THE DEMANDS OF THE 4K ERA

## Canon Cinema Lens Technology

### Optical Performance

#### Crystal Clear Canon Optical Technology

##### Super 35mm-compatible, 4K

From the center to the periphery of our cinema lenses, a high-quality 4K image is achieved for both single focus and zoom lenses within the entire zoom range. Canon's optical technologies are combined to help correct various aberrations and provide high contrast while achieving a high resolution of about 80 lines/mm throughout the Super 35 mm sensor.

#### Fluorite Critical to Producing 4K High Image Quality

Canon has always made an effort to research special elements since its beginnings in this industry with the goal of minimizing chromatic aberration. These efforts have included an artificially re-crystallized "Fluorite" with outstanding dispersion characteristics and the developed "Hi-UD\*" (high-index, ultra-low dispersion) glass. Canon has developed artificial crystallization technology capable of supporting large diameters exceeding 200mm.

These special elements are also critical for EF cinema zoom lenses with high magnification, as they provide for sharp, clear telephoto shooting with little chromatic aberration.

*\*Excluding COMPACT-SERVO Lenses*

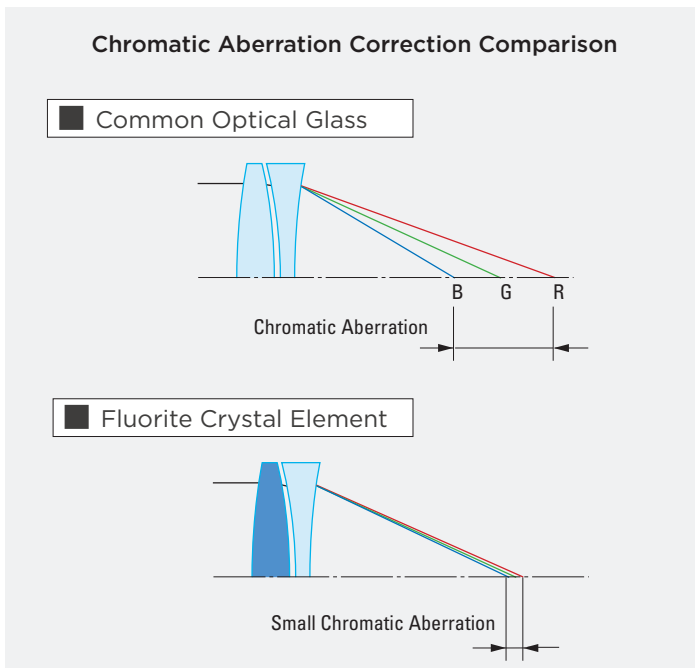

#### Large Aperture Aspherical Lenses

Aspherical lenses are capable of correcting aberrations with just a single lens where typically multiple spherical lenses are required. As a result, the number of component lenses can be reduced in the lens as a whole, simultaneously achieving high image quality while reducing size and weight. Canon's process of molding and grinding aspherical glass allows for the stable production of high performance aspherical lenses.

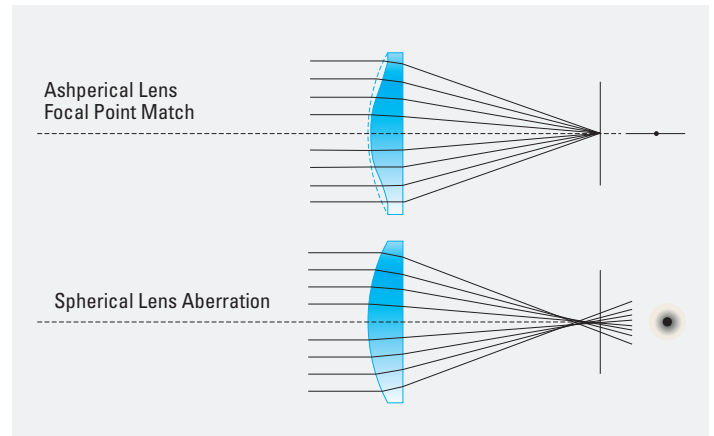

#### Focus Breathing Suppression

Focus breathing is caused when the focus group moves and exerts a "zooming" effect. In order to prevent this, cinema lenses implement a 3-group inner focus method and a new floating method to help minimize field angle fluctuation and achieve stable framing.

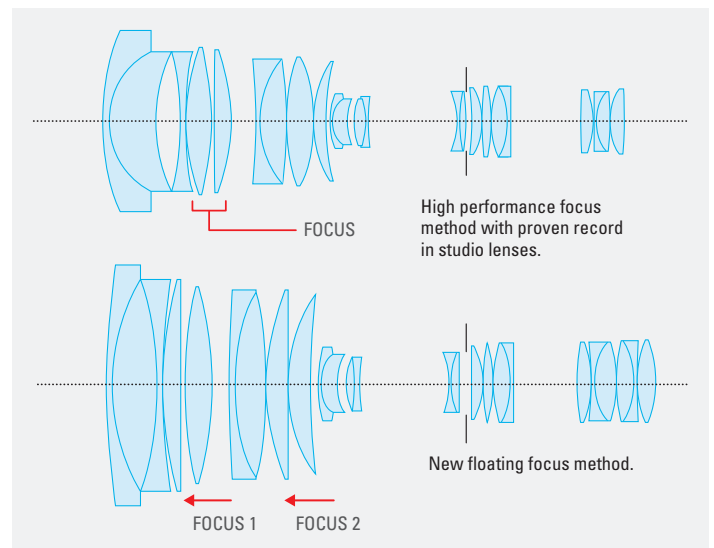

## 11 Blade Aperture

Halos from points of light at night or from rays of sunlight in shots that show the sun take on the shape of the Iris blades. The additional blades make the Iris aperture look circular even when the Iris is contracted, enabling beautiful, round highlight bokeh.

\*COMPACT-SERVO lens has 9 blade iris.



• When converting to 2/3 type image size, the real focal length is about 0.39 times.

## Color Balance

Cinema lens color balance, ideal for movie production, reproduces warm skin tones. Color balance is strictly uniform across all Canon cinema lenses making lens substitution during the same scene possible. Anti-reflection film technology, including super spectral coatings and thorough corrections for slight color variations caused by glass components allow Canon lenses to achieve this effect.

## Flange Back Adjustment

A flange back adjustment mechanism is installed on the lens mounts to allow for back focus adjustments.

\* Excluding PRIME Lens series.

## Cinema Lens Focal Distance Table

ZOOM Lenses						
Angle of view horizontal (1.78:1)*1	79.2°	43.6°	22.6°	4.6°		
Focal Distance (mm)	14.5	30	60	300		
CN-E14.5-60mm T2.6 L	[Progressive bar]					
CN-E30-300mm T2.95-3.7 L	[Progressive bar]					
COMPACT ZOOM Lenses						
Angle of view horizontal (1.78:1)*2	75.5°	43.6°	28.6°	13.0°		
Focal Distance (mm)	15.5	30	47	105		
CN-E15.5-47mm T2.8 L	[Progressive bar]					
CN-E30-105mm T2.8 L	[Progressive bar]					
PRIME Lenses						
Angle of view horizontal (1.78:1)*2	82.6°	54.3°	38.7°	27.6°	16.5°	10.4°
Focal Distance (mm)	14	24	35	50	85	135
CN-E14mm T3.1 L F	●					
CN-E24mm T1.5 L F		●				
CN-E35mm T1.5 L F			●			
CN-E50mm T1.3 L F				●		
CN-E85mm T1.3 L F					●	
CN-E135mm T2.2 L F						●
CINE-SERVO Lenses						
Angle of view horizontal (1.78:1)*2	71.8°	27.6°	11.7°	1.4°		
Focal Distance (mm)	17	50	120	1000		
CN7×17 KAS S	[Progressive bar]					
CN20×50 IAS H	[Progressive bar]					
COMPACT-SERVO Lenses						
Angle of view horizontal (1.78:1)*2	68.7°	19.9°	17.5°	7.0°		
Focal Distance (mm)	18	70	80	200		
CN-E70-200mm T4.4 L IS KAS S	[Progressive bar]					
CN-E18-80mm T4.4 L IS KAS S	[Progressive bar]					

\*1: When the screen size is 24.0 × 13.5 mm. \*2: When the screen size is 24.6 × 13.8 mm.

■ **Luminous Index**

The focus index on the front lens barrels is printed with luminescent paint to improve visibility at night and in dark studio conditions.



**Dust/Splash Resistant Seals and Casing\***

Our prime lenses use dust and splash resistant rubber gaskets at the casing joints.

*\* Lenses are not designed to be submersible in water or exposed to heavy rain.*



**ZOOM / COMPACT ZOOM Lens Series: Highlights**

**Easy-to-Read Controls**

Focus, Zoom, and Iris markings are provided on angled surfaces. These markings are easy to read from behind the camera.

**Support Industry-Standard Cameras**

Supports industry-standard Super 35mm equivalent and APS-C formats.

**Light, Compact**

Small and light to meet a variety of shooting needs.

**Marked on Both Sides**

Lenses are marked on both sides. This makes markings visible from either side of the lens.

**Switchable Unit for Focus Marking**

The outer piece on marked focus rings can be switched from non-metric to metric labeling.

**Comfortable Usability**

Control rings maintain the right amount of resistance while offering exceptional usability with consistent operating torque.

**Inner Focus**

Helps minimize focus-induced changes in the angle of view.

**Unified Front Lens Diameter, Gear Position**

Uniform gear positions within the same categories eliminate the need for accessory gear position adjustment when switching lenses.

**Zoom Lens Series**



**Compact Zoom Lens Series**



**Attractive Blurring**

11-Blade Circular Aperture enables soft, beautiful background bokeh.

**Flange-Back Adjustment Mechanism**

A covered flange-back adjustment mechanism is included, with broadcast applications in mind.



**PRIME Lens Series: Highlights**

**Ready for Full-size 35mm Sensors**

The lenses are also compatible with the large imaging area of cameras equipped with a full-size 35mm-equivalent CMOS sensor.

**Light, Compact**

Small and light among many conventional cinema lenses, to meet a variety of shooting needs.

**Standard Accessories Supported**

Supports industry-standard accessories such as power-drive devices and matte boxes.

**Accepts 105mm filters (except for 14mm)**

PL or other individual filters 105mm in diameter can be attached to the end of the lens, enabling filter work in handheld shooting or other scenarios without using a matte box.

**Fast Aperture**

Enables shooting with the shallow DOF and broad bokeh that large sensors offer.

**Unified Front Lens Diameter, Gear Position**

Compact Zoom and Prime lenses have the same front lens diameter and consistent gear positions, so lenses within each series can be switched without adjusting the rig setup.

**Prime Lens Series**

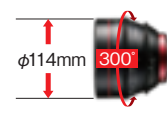

**Attractive Blurring**

11-Blade Circular Aperture enables soft, beautiful background bokeh.

**Comfortable Usability**

Control Rings maintain the right amount of resistance while offering outstanding usability with consistent operating torque.

**Switchable Unit for Focus Marking**

The outer piece on marked focus rings can be switched from non-metric to metric labeling.



## CINE-SERVO 50-1000mm: Highlights

**Designed for Super35mm Large-Format Single-Sensor Cameras**

**Robust and Durable Housing Structure**

**20x Zoom Magnification**

**Ultra Telephoto  
50-1000mm Focal Range**

**4K Ready**

High optical performance with support for Super35mm large format cameras.



**Removable Servo Drive Unit**

Removable servo drive unit with various user setting capabilities.

**Built-In 1.5x Optical Extender**

**Accessory Connectors**

Three 20-pin connectors for externally operated accessories and a 16-bit metadata output for virtual studio systems.



**Multiple Communication Capability with Compatible Cameras**

**11-Blade Iris Provides Natural Bokeh**

**Designed for Cinema and Broadcast Applications**

**Compact and Lightweight**

Compact and lightweight lens available in an EF mount and PL mount that can be converted at an authorized Canon service facility.



EF Mount



PL Mount

## CINE-SERVO 17-120mm: Highlights

**High Durability and Ruggedness**

**7x Zoom Magnification**

**Wide 17-120mm Focal Range**

**Ergonomic Design**

Ergonomically designed drive unit for ease of operation.

**4K Ready**

High optical performance with support for Super35mm large format cameras.



**Removable Servo Drive Unit**

Removable servo drive unit with various user setting capabilities.

**Accessory Connectors**

Three 20-pin connectors for externally operated accessories and a 16-bit metadata output for virtual studio systems.



**Multiple Communication Capability with Compatible Cameras**

**11-Blade Iris Provides Natural Bokeh**

**Designed for Cinema and Broadcast Applications**

**Compact and Lightweight**

Compact and lightweight lens available in an EF mount and PL mount that can be converted at an authorized Canon service facility.



EF Mount



PL Mount

## Drive Unit

### Removable Drive Unit

Canon CINE-SERVO lenses include a drive unit that provides the same user experience as found in our broadcast zoom lenses. Removing the drive unit allows for full manual operation of the lenses.



### ■ No Initialization

Initialization of the drive unit is not required at power-on. Initialization is required at power-on for conventional drive units. Immediate startup helps contribute to more efficient shooting.

### Compatible With Standard Broadcast Demands

#### Demand Supported

Compatible with Canon's standard broadcast industry demands such as ZSD-300D and FPD-400D. Canon's 8-pin demand\* can be connected via a conversion cable.

\* Excludes the ZSD-350M.

### Enables High-Precision, Natural Composition

#### Virtual Studio System

A high precision 16-bit encoder (zoom and focus only) makes connection to various virtual studio systems possible. Three, 20-pin terminals allow a virtual connection even when zoom and focus demands are connected.

\* Iris operation is also possible by connecting FDJ-P01 via conversion cable. It will be selected as either virtual output or iris operation.



### Ambient Light Intensity Correction Is Also Possible

#### EF Mount Communication Protocol Support<sup>1</sup>

Information communication is possible via CINEMA EOS SYSTEM cameras and mounts. It is possible to record lens information at the time of shooting and ambient light intensity correction<sup>2</sup>.

\*1: ZOOM Lenses are excluded. Only EF mounted lenses are supported.

\*2: Some lenses require a camera firmware update. Some lenses are scheduled to be handled by firmware update.

### Supports Broadcast Industry Standards

#### 12-Pin Serial Communication Capable\*

Supports 12-pin serial communication which is a broadcasting communication standard.

\* Applicable lens: CINE-SERVO Lens series.

It is necessary for the camera side to support 12 pin serial communication.

### Supports Communication Standards of Film Production Industry

#### /i Technology Compatible\*

Canon's PL-mount CINE-SERVO lenses are compatible with Cooke's "/i Technology" communication standard which has been widely adopted throughout the video production industry. Focus/zoom/aperture position data can be sent to the corresponding camera, recorded and displayed.

\* Applicable lens: PL mount lens of CINE-SERVO Lens series only. The camera side must support /i Technology.

Communication is possible when drive unit is installed.



## ZOOM Lens Series

Appearance		<b>CN-E14.5-60mm T2.6 L S</b> <b>CN-E14.5-60mm T2.6 L SP</b> 		<b>CN-E30-300mm T2.95-3.7 L S</b> <b>CN-E30-300mm T2.95-3.7 L SP</b> 	
Model Name	CN-E14.5-60mm T2.6 L S	CN-E14.5-60mm T2.6 L SP	CN-E30-300mm T2.95-3.7 L S	CN-E30-300mm T2.95-3.7 L SP	
Mount	EF Mount	PL Mount	EF Mount	PL Mount	
Zoom Ratio	4.1x		10x		
Focal Length	14.5 ~ 60mm		30 ~ 300mm		
Max. Relative Aperture (T-Number)	T2.6 14.5 ~ 60mm		T2.95 30 ~ 240mm / T3.7 300mm		
Iris Blades	11		11		
Angle of View	1.5:1 36.0x24.0mm	79.2°x49.9° 14.5mm 22.6°x12.8° 60mm <sup>*1</sup>	43.6°x25.4° 30mm 4.6°x2.6° 300mm <sup>*1</sup>		
	1.9:1 26.2x13.8mm	80.6°x50.9° 14.5mm 23.2°x13.1° 60mm <sup>*2</sup>	44.6°x25.9° 30mm 4.7°x2.6° 300mm <sup>*2</sup>		
M.O.D. (Minimum Object Distance)	0.70m/2'4"		1.5m/5'		
Object Dimensions at M.O.D	1.5:1 36.0x24.0mm	65.2x36.7cm 14.5mm 15.0x8.4cm 60mm <sup>*1</sup>	98.8x55.6cm 30mm 9.6x5.4cm 300mm <sup>*1</sup>		
	1.9:1 26.2x13.8mm	66.9x37.5cm 14.5mm 15.4x8.6cm 60mm <sup>*2</sup>	101.3x56.8cm 30mm 9.9x5.6cm 300mm <sup>*2</sup>		
Image Size	29.6mm		29.6mm		
Front Diameter	136.0mm		136.0mm		
Approx. Size (WxHxL)	5.35x6.42x12.83 in. (136.0x163.1x326.0mm)	5.35x6.42x12.52 in. (136.0x163.1x318.0mm)	5.67x6.58x13.78 in. (144.0x167.1x350.1mm)	5.67x6.58x13.47 in. (144.0x167.1x342.1mm)	
Approx. Weight	9.9 lbs (4.5kg)		12.79 lbs (5.8kg)		

※ Lenses compatible with Super 35mm Sensor cameras.

\*1: Aspect ratio 1.78: 1, Screen size 24.0 x 13.5 mm. \*2: Aspect ratio 1.78:1, Screen size 24.6 x 13.8 mm

## COMPACT ZOOM Lens Series

Appearance		<b>CN-E15.5-47mm T2.8 L S</b> <b>CN-E15.5-47mm T2.8 L SP</b> 		<b>CN-E30-105mm T2.8 L S</b> <b>CN-E30-105mm T2.8 L SP</b> 	
Model Name	CN-E15.5-47mm T2.8 L S	CN-E15.5-47mm T2.8 L SP	CN-E30-105mm T2.8 L S	CN-E30-105mm T2.8 L SP	
Mount	EF Mount	PL Mount	EF Mount	PL Mount	
Zoom Ratio	3x		3.5x		
Focal Length	15.5 ~ 47mm		30 ~ 105mm		
Max. Relative Aperture (T-Number)	T2.8 15.5 ~ 47mm		T2.8 30 ~ 105mm		
Iris Blades	11		11		
Angle of View	1.5:1 36.0x24.0mm	75.5°x47.1° 15.5mm 28.6°x16.3° 47mm <sup>*1</sup>	43.6°x25.4° 30mm 13.0°x7.4° 105mm <sup>*1</sup>		
	1.9:1 26.2x13.8mm	80.4°x48.0° 15.5mm 31.1°x16.7° 47mm <sup>*2</sup>	47.2°x25.9° 30mm 14.2°x7.5° 105mm <sup>*2</sup>		
M.O.D. (Minimum Object Distance)	0.50m/1'8"		0.60m/2'		
Object Dimensions at M.O.D	1.5:1 36.0x24.0mm	43.6x24.5cm 15.5mm 14.1x7.9cm 47mm <sup>*1</sup>	32.3x18.2cm 30mm 9.3x5.2cm 105mm <sup>*1</sup>		
	1.9:1 26.2x13.8mm	47.6x25.1cm 15.5mm 15.4x8.1cm 47mm <sup>*2</sup>	35.3x18.6cm 30mm 10.2x5.4cm 105mm <sup>*2</sup>		
Image Size	31.4mm		31.4mm		
Front Diameter	114mm		114mm		
Approx. Size (WxHxL)	4.49x4.92x8.74 in. (114.0x125.0x222.0mm)	4.49x4.92x8.43 in. (114.0x125.0x214.0mm)	4.49x4.92x8.58 in. (114.0x125.0x218.0mm)	4.49x4.92x8.26 in. (114.0x125.0x210.0mm)	
Approx. Weight	4.85 lbs (2.2kg)		4.85 lbs (2.2kg)		

※ Lenses compatible with Super 35mm Sensor cameras.

\*1: Aspect ratio 1.78:1, Screen size 24.0 x 13.5 mm. \*2: Aspect ratio 1.78:1, Screen size 24.6 x 13.8 mm

# PRIME Lens Series

		CN-E14mm T3.1 L F	CN-E24mm T1.5 L F	CN-E35mm T1.5 L F
Appearance				
Model Name		CN-E14mm T3.1 L F	CN-E24mm T1.5 L F	CN-E35mm T1.5 L F
Mount		EF Mount	EF Mount	EF Mount
Zoom Ratio		–	–	–
Focal Length		14mm	24mm	35mm
Max. Relative Aperture (T-Number)		T3.1	T1.5	T1.5
Iris Blades		11	11	11
Angle of View	1.5:1 36.0x24.0mm	104.3°×81.2° *1	73.7°×53.1° *1	54.4°×37.8° *1
	1.9:1 26.2x13.8mm	82.6°×52.5° *2	54.3°×32.1° *2	38.7°×22.3° *2
M.O.D. (Minimum Object Distance)		0.20m / 8"	0.30m / 12"	0.30m / 12"
Object Dimensions at M.O.D	1.5:1 36.0x24.0mm	24.8×16.5cm *1	28.8×19.2cm *1	20.1×13.4cm *1
	1.9:1 26.2x13.8mm	16.9×9.5cm *2	19.7×11.0cm *2	13.7×7.7cm *2
Front Diameter		114mm	114mm	114mm
Approx. Size (WxHxL)		4.66x4.66x3.70 in. (118.4x118.4x94.0mm)	4.66x4.66x4.0 in. (118.4x118.4x101.5mm)	4.66x4.66x4.0 in. (118.4x118.4x101.5mm)
Approx. Weight		2.65 lbs (1.2kg)	2.65 lbs (1.2kg)	2.43 lbs (1.1kg)

		CN-E50mm T1.3 L F	CN-E85mm T1.3 L F	CN-E135mm T2.2 L F
Appearance				
Model Name		CN-E50mm T1.3 L F	CN-E85mm T1.3 L F	CN-E135mm T2.2 L F
Mount		EF Mount	EF Mount	EF Mount
Zoom Ratio		–	–	–
Focal Length		50mm	85mm	135mm
Max. Relative Aperture (T-Number)		T1.3	T1.3	T2.2
Iris Blades		11	11	11
Angle of View	1.5:1 36.0x24.0mm	39.6°×27.0° *1	23.9°×16.1° *1	15.2°×10.2° *1
	1.9:1 26.2x13.8mm	27.6°×15.7° *2	16.5°×9.3° *2	10.4°×5.9° *2
M.O.D. (Minimum Object Distance)		0.45m / 18"	0.95m / 3'2"	1.0m / 3'3"
Object Dimensions at M.O.D	1.5:1 36.0x24.0mm	24.9×16.6cm *1	34.3×22.9cm *1	21.1×14.1cm *1
	1.9:1 26.2x13.8mm	17.0×9.5cm *2	23.4×13.1cm *2	14.4×8.1cm *2
Front Diameter		114mm	114mm	114mm
Approx. Size (WxHxL)		4.66x4.66x4.0 in. (118.4x118.4x101.5mm)	4.66x4.66x4.0 in. (118.4x118.4x101.5mm)	4.66x4.66x4.55 in. (118.4x118.4x115.6mm)
Approx. Weight		2.43 lbs (1.1kg)	2.87 lbs (1.3kg)	3.09 lbs (1.4kg)

\*: Lenses compatible with Super 35mm Sensor cameras.

\*1: Aspect ratio 1.5:1, Screen size 36.0 × 24.0 mm. \*2: Aspect ratio 1.78:1, Screen size 24.6 × 13.8 mm.

## CINE-SERVO Lens Series

Appearance	CN7×17 KAS S/E1 CN7×17 KAS S/P1		CN20×50 IAS H/E1 CN20×50 IAS H/P1	
				
Model Name	CN7×17 KAS S/E1	CN7×17 KAS S/P1	CN20×50 IAS H/E1	CN20×50 IAS H/P1
Mount	EF Mount	PL Mount	EF Mount	PL Mount
Zoom Ratio	7×		20×	
Focal Length	17 – 120mm		50 – 1000mm	75 – 1500mm <sup>*3</sup>
Max. Relative Aperture (T-Number)	T2.95 17 – 91mm / T3.9 120mm		T5.0 (50-560mm) / T8.9 (1000mm)	T7.5 (75-840mm) / T13.35 (1500mm) <sup>*3</sup>
Iris Blades	11		11	
Angle of View	1.5:1 36.0x24.0mm	71.8°×44.2° 17mm 11.7°×6.6° 120mm <sup>*1</sup>	27.6°×15.7° 50mm 1.4°×0.8° 1000mm <sup>*1</sup>	18.6°×10.5° 75mm 0.9°×0.5° 1500mm <sup>*1, *3</sup>
	1.9:1 26.2x13.8mm	75.2°×44.2° 17mm 12.5°×6.6° 120mm <sup>*2</sup>	29.4°×15.7° 50mm 1.5°×0.8° 1000mm <sup>*2</sup>	19.8°×10.5° 75mm 1.0°×0.5° 1500mm <sup>*2, *3</sup>
M.O.D. (Minimum Object Distance)	0.85m/2.8'		3.5m/11.5'	
Object Dimensions at M.O.D	1.5:1 36.0x24.0mm	86.3×48.4cm 17mm 12.0×6.7cm 120mm <sup>*1</sup>	139.3×78.1cm 50mm 7.3×4.1cm 1000mm <sup>*1</sup>	92.9×52.1cm 75mm 4.9×2.7cm 1500mm <sup>*1, *3</sup>
	1.9:1 26.2x13.8mm	92.1×48.5cm 17mm 12.7×6.7cm 120mm <sup>*2</sup>	148.3×78.1cm 50mm 7.8×4.1cm 1000mm <sup>*2</sup>	98.9×52.1cm 75mm 5.2×2.7cm 1500mm <sup>*2, *3</sup>
Image Size	31.4mm		31.4mm	
Front Diameter	114mm		136.0mm	
Approx. Size (WxHxL)	6.86x4.92x10.35 in. (174.2×125.0×262.9mm)	6.86x4.92x10.04 in. (174.2×125.0×254.9mm)	6.89x6.72x16.27 in. (175.0×170.6×413.2mm)	6.89x6.72x15.95 in. (175.0×170.6×405.2mm)
Approx. Weight	6.39 lbs (2.9kg)		14.55 lbs (6.6kg)	

※ Lenses compatible with Super 35mm Sensor cameras.

\*1: Aspect ratio 1.78:1, Screen size 24.6 x 13.8 mm. \*2: Aspect ratio 1.9:1, Screen size 26.2 x 13.8 mm. \*3: When using the built-in extender.

## COMPACT-SERVO Lens Series: Highlights

### Refined Iris Mechanism

- Seamless Manual Control Capability
- 9-Blade Iris
- Iris Closing

### Compatible with EF-mount Cameras

### Supports a Wide Range of Accessories

### Practical Layout of Switches

### Compact and Lightweight for Increased Mobility

### Dual Pixel CMOS Auto-Focus (DAF)

### Enhanced Servo Drive Unit

- Servo Control Capability for all Zoom, Focus, and Iris
- Compatible with broadcast style servo lens controllers
- Optional ZSG-C10 Grip

### High Level 4K Optical Performance

### Image Stabilization

### 4.4x Zoom Magnification

### Minimized Focus Breathing



4K

COMPACT-SERVO

## COMPACT-SERVO Lens Series

		CN-E18-80mm T4.4 L IS KAS S	CN-E70-200mm T4.4 L IS KAS S
Appearance			 <b>NEW</b>
Model Name		CN-E18-80mm T4.4 L IS KAS S	CN-E70-200mm T4.4 L IS KAS S
Mount		EF Mount	EF Mount
Zoom Ratio		4.4x	2.8x
Focal Length		18 ~ 80mm	70 ~ 200mm
Max. Relative Aperture (T-Number)		T4.4 18 ~ 80mm	T4.4 70 ~ 200mm
Iris Blades		9	9
Angle of View	1:5:1 36.0x24.0mm	68.7°×41.9° 18mm 17.5°×9.9° 80mm <sup>*1</sup>	19.9°×11.3° 70mm 7.0°×4.0° 200mm <sup>*1</sup>
	1.9:1 26.2x13.8mm	72.1°×41.9° 18mm 18.6°×9.9° 80mm <sup>*2</sup>	21.2°×11.3° 70mm 7.5°×4.0° 80mm <sup>*2</sup>
M.O.D. (Minimum Object Distance)		0.5m/1.7'	1.2m/4.0'
Object Dimensions at M.O.D.	1:5:1 36.0x24.0mm	43.4×24.3cm 18mm 9.5×5.3cm 80mm <sup>*1</sup>	31.3×17.5cm 70mm 11.5×6.4cm 200mm <sup>*1</sup>
	1.9:1 26.2x13.8mm	46.2×24.3cm 18mm 10.1×5.3cm 80mm <sup>*2</sup>	33.3×17.5cm 70mm 12.2×6.4cm 200mm <sup>*2</sup>
Front Diameter		84mm	84mm
Approx. Size (WxHxL)		3.67×4.22×7.18 in. (93.4×107.2×182.3mm)	3.67×4.22×7.18 in. (93.4×107.2×182.3mm)
Approx. Weight		2.65 lbs (1.2kg) (including servo unit)	2.76 lbs (1.25kg) (including servo unit)

### COMPACT-SERVO Lens Accessories

#### ZSG-C10



- Rocker seesaw
- Start/Stop button<sup>\*1</sup>
- ONE-SHOT AF button<sup>\*1</sup>
- 20 PIN cable<sup>\*2</sup>
- Flexible mounting angle.

※ Sold separately.

※ Support strut, bracket, hex wrench included.

\*1: For compatible cameras, please visit our website: [cinemaeos.usa.canon.com](http://cinemaeos.usa.canon.com)

\*2: For connection to the lens body.

※ Lenses compatible with Super 35mm Sensor cameras.

\*1: Aspect ratio 1.78:1, Screen size 24.6 x 13.8 mm.

\*2: Aspect ratio 1.9:1, Screen size 26.2 x 13.8 mm.

## CINE-SERVO Lens / COMPACT-SERVO Lens Accessories

Category	Model	Notes	CN7×17 KAS S/E1 CN7×17 KAS S/P1	CN20×50 IAS H/E1 CN20×50 IAS H/P1	CN-E18-80mm CN-E70-200mm
Focus Demand	FPD-400D	There is no need for an optional cable.	●	●	● ※1 ※2
	FDJ-D02	BDC - 11 cable (20p - 18p) is required.	●	●	—
	FDJ-P01	BDC - 21 cable (20p - 12p) is required.	●	●	—
Zoom Demand	ZSD-300D	There is no need for an optional cable.	●	●	● ※1 ※2
	ZDJ-D02	BDC - 11 cable (20p - 18p) is required.	●	●	—
	ZDJ-P01	BDC - 21 cable (20p - 12p) is required.	●	●	—
Iris Demand	FDJ-D02	BDC - 11 cable (20p - 18p) is required.	●	●	—
	FDJ-P01	BDC - 21 cable (20p - 12p) is required.	●	●	—
Demand Cable	BDC-21	20p - 12p cable. Required for FDJ-P01 / ZDJ-P01 / ZDJ-DN2.	●	●	—
	BDC-11	20p - 18p cable. It is necessary for FDJ-D 02 / ZDJ-D 02.	●	●	—
Clear Filter	CL/112MM	CL/112MM	●	—	—
	CL/127MM-H	CL/127MM-H	●	●	—
Lens Holder	LH-CN7/02	Used when you want to improve the degree of freedom of Focus ring rotation operation. (The lens support attached to the main unit is supported on the front side.)	●	—	—
Power Cable	C-ZLPRO*	For power supply from external battery. 12-pin - Dtap cable.	●	●	—

\* Made by IDX.

※ 1: Multiple controllers can not be connected at the same time (because there is only one connector). When installing the ZSG - C10 and enabling the operation on the grip side, you can not connect the external controller.  
 ※ 2: For use in studio configurations, an optional Zacuto Z-CNYC. Y-cable can be used to connect zoom and focus controllers to each lens. This configuration allows for simultaneous zoom and focus operation with COMPACT-SERVO lenses.

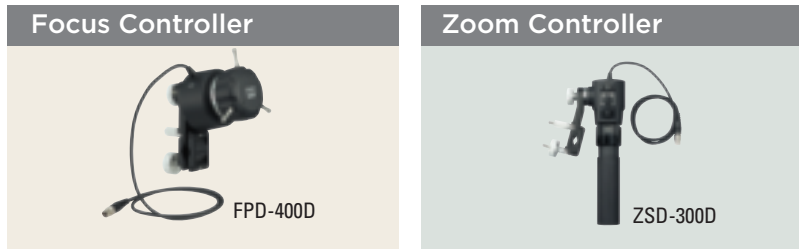

### Lens System Basic Configuration

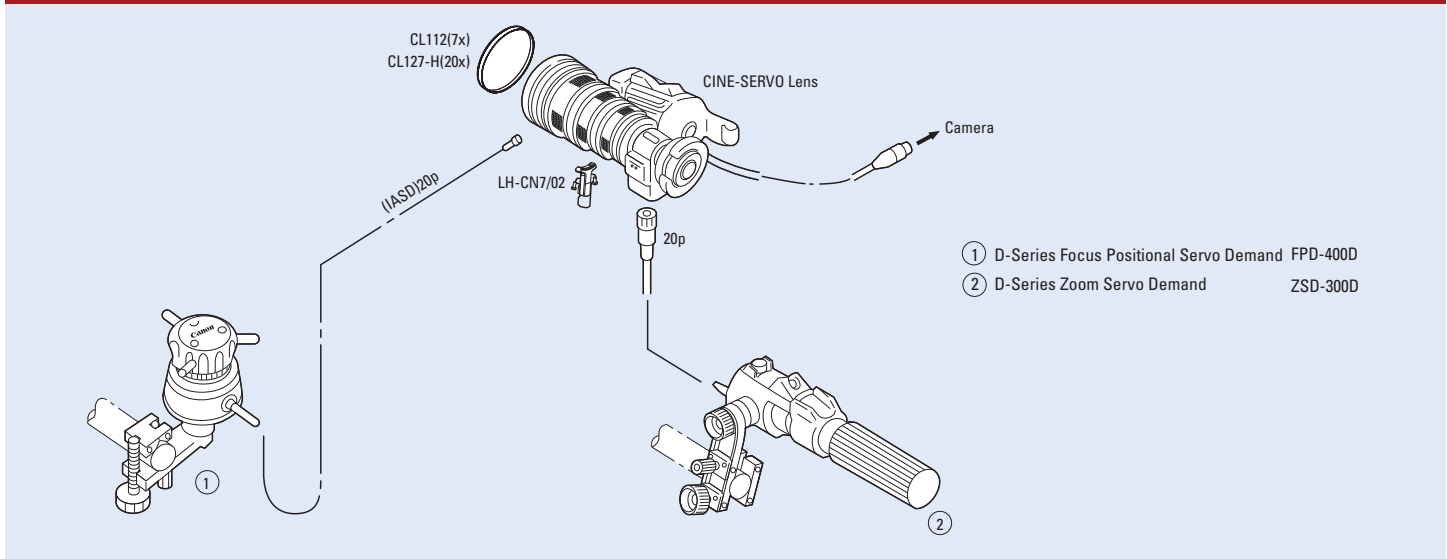



# High Definition PTZ Cameras



## EVERCAM XU-81 and EVERCAM XU-81W

### ENGINEERED TO LAST

As the worldwide transition to HD imaging continues to accelerate, many video content creators—including broadcasters, cable networks, Houses of Worship, and diverse businesses are seeking cost-effective, turnkey, remotely-controllable Pan-Tilt-Zoom HD camera systems to provide unique visual perspectives while helping to ensure high image quality of the production. In order to satisfy these demands, Canon has combined its highly advanced technology, developed over many years, to successfully engineer the EVERCAM XU-81 and XU-81W cameras.

The XU-81 and XU-81W cameras feature a 1/3" CMOS imaging sensor with 2.1 megapixels and an optical 20x zoom lens (along with the 12x digital zoom) that supports Auto Focus. They achieve astounding performance that enables them to be used in high end production applications. Along with the aluminum die-cast body, they also feature a dust proof and water proof (IP55) construction and are small and lightweight enough to be carried around. These features allow these multi-use products, with their excellent durability, to be installed in virtually any location, whether indoors or outdoors.

Canon is firmly committed to researching and developing cutting-edge technological innovations in an effort to deliver innovative products capable of reproducing some of the world's most beautiful images.

## BU-47H

### Outdoor Remote Control Pan-Tilt System

To meet the diverse needs of outdoor broadcasters, cable networks, businesses, industrial entities, weather monitoring, and traffic POV, Canon has created a solution for cost-effective, turnkey, remotely-controllable Pan-Tilt-Zoom (PTZ) HD Camera systems allowing users to extend creative flexibilities. Canon has harnessed multiple unique technologies and experience in HD optics and digital cameras, robotics, and control software to produce a cost-effective, integrated HD lens-camera PTZ product offering outstanding HD picture quality. The BU-47H is a rugged yet elegant outdoor PTZ system following a legacy of decades of Canon expertise in designing such systems. A sister product, the BU-51H, has a design tailored for indoor applications.



**XU-81**





**XU-81W**

With wiper and ND filter for outdoor installation



**BU-47H**

## HD PTZ Cameras

	<b>BU-47H</b>	<b>EVERCAM XU-81</b>	<b>EVERCAM XU-81W</b> With wiper and ND filter for outdoor installation
Appearance			
Model Name	BU-47H	EVERCAM XU-81	EVERCAM XU-81W
Operation Condition	Outdoor	Indoor	Outdoor
Operation Angle	Pan: 340° Tilt: +30°~50°	Pan: ±180° Tilt: +220°~40°	Pan: ±180° Tilt: +220°~40°
Operation Speed	Panning: 0.5° ~ 25°/s Tilting: 0.3° ~ 20°/s	Pan/Tilt: 0.3~40°/s (normal speed mode) Pan/Tilt: 0.3~60°/s (high speed mode)	Pan/Tilt: 0.3~40°/s (normal speed mode) Pan/Tilt: 0.3~60°/s (high speed mode)
Repeatability	Less than ±10 arc degrees	Within ±10 arc degrees	Within ±10 arc degrees
Wiper	Built-in Electric Wiper	None	Built-in Electric Wiper
Mic Input	Jack provided, pedestal section	Waterproof Microphone: lower part of the camera / 0dBm / 600 unbalanced output (with limiter)	Waterproof Microphone: lower part of the camera / 0dBm / 600 unbalanced output (with limiter)
Input/Output Connectors	DC terminal, Control (RS-422), SDI out, SD composite, Genlock, Aux out	5mm DC barrel-type; DB-9 (RS-232), RJ-45 (RS-422), HD-SDI out, Genlock, SD composite	5mm DC barrel-type; DB-9 (RS-232), RJ-45 (RS-422), HD-SDI out, Genlock, SD composite
Video Output	HD-SDI (embedded audio) BNC output x 1 (receptacle unit) SD analog composite BNC output x 1	HD: BNC (HD-SDI), SD: BNC (Composite Monitor)	HD: BNC (HD-SDI), SD: BNC (Composite Monitor)
Genlock Input	BNC (receptacle unit) (tri-level/black burst)	BNC (BB Sync/HD3value Sync)	BNC (BB Sync/HD3value Sync)
Operating Temperature	5°C to 40°C, less than 90% humidity (no condensation)	Ambient -15~40°C / ~90% (non-condensing)	Ambient -15~40°C / ~90% (non-condensing)
Wind Velocity-Resistance	Normal Operation: 0~55m / s Operation Possible: 55 ~ 78m / s * Non Destruction: 78 ~ 134m / s	Normal Operation: ~15mm / s Operation Possible: ~30m / s Non Destruction: ~60m / s	Normal Operation: ~15m / s Operation Possible: ~30m / s Non Destruction: ~60m / s
Noise	NC55 below	NC30 (40° / s), NC45 (60° / s)	NC30 (40° / s), NC45 (60° / s) (when Wiper, ND Filter, and IRC Filter are not in operation)
Power Source	DC10.5~15V, 80W	DC12V±10%	DC12V±10%
Dustproof Waterproof Efficiency	IP45	IP55	IP55
Image Sensor	1/3" CMOS x 3 (HD CMOS PRO)	1/3" HD CMOS, total of ~ 2.1 million pixels	1/3" HD CMOS, total of ~ 2.1 million pixels
Range Of Focal Length / F No.	f=4.1-73.8mm / F1.6-2.8	f=4.7-94mm / F1.6-3.5	f=4.7-94mm / F1.6-3.5
Zoom Ratio	18x Optical Zoom (1.5x digital extender)	20x Optical Zoom (12x digital extender)	20x Optical Zoom (12x digital extender)
Dimensions (W x D x H) (Including Camera & Lens)	15.19x13.2x15.35 in. (386x337x390 mm)	8.54x8.54x12.24 in. (217x217x311 mm (without projection))	8.54x8.54x12.24 in. (217x217x311 mm (without projection))
Weight (Including Camera & Lens)	37.4 lbs (Approx. 16.9kg)	14.55 lbs (6.6kg) (without ND Filter and Wiper)	14.55 lbs (6.6kg) (without ND Filter and Wiper)

\*Some functions may be limited depending on operating environment.

# Notes

# Notes